



Laboratory water purification systems



WATER PURIFICATION SYSTEMS

Adrona water purification systems provide ultrapure (Grade 1), pure (Grade 2) and reverse osmosis (RO) water for laboratory needs. The quality of water meets the requirements of ISO 3696 standard and corresponding ASTM and CLSI standards.

Tap water systems	Water type	Page No.
Gradus	Ultrapure, pure	6
B300 & B310	Ultrapure, pure, RO ¹	9
Q-Front N	Ultrapure, pure	12
Q-Front	Ultrapure, RO	14
Q-Front EDI	Ultrapure, pure	16
Q-Front (EDI) Pure	Pure	18
Integrity +	Ultrapure	20
E30	Ultrapure, pure	22
Crystal EX	Ultrapure, pure, RO ¹	24
Crystal EX Pure, Double, RO	Pure, RO	26
Crystal Sterifeed	Pure	29

Polishing systems	Water type	Page No.
Onsite +	Ultrapure	30
Connect	Ultrapure	32
Connect LT	Ultrapure	34
Central laboratory systems		
Radix	Pure, RO	36
Accessories		38

1 Depending on the model, water purification systems can produce ultrapure and pure water or RO and pure water.

ADRONA LABORATORY ULTRAPURE WATER SYSTEMS FEATURES

	Crystal EX	Q-Front	Q-Front N Q-Front EDI	Integrity+	Gradus B300	B310	Connect Onsite+	Connect LT
Feed water	Tap water	Tap water	Tap water	Tap water	Tap water	Tap water	Pre-treated	Pre-treated
Produced water	Grade 2 Grade 1	RO Grade 1	Grade 2 Grade 1	Grade 1	Grade 2 Grade 1	RO Grade 2 Grade 1	Grade 1	Grade 1
Display	Mono chrome	Colour	Colour	Colour	Touch screen	Touch screen	Colour	Touch screen
TOC monitor	-	✓	✓	✓	✓	✓	✓	✓
Volumetric dispense	-	✓	✓	✓	✓	✓	✓	✓
Data Interface	-	RS232	RS232	RS232	Ethernet USB	Ethernet USB	RS232	Ethernet USB
Dispense reports	-	-	-	-	✓	✓	-	✓
Data storage	-	-	-	-	✓	✓	-	✓
GLP	-	-	-	-	✓	✓	-	✓
Remote diagnostic	-	-	-	-	✓	✓	-	✓

OVERVIEW

Adrona provides laboratory water solutions to any application – starting from Primary Grade Water (Grade 3) for simple washing and autoclave feed to Purified Water (Grade 2) for general laboratory use or Ultrapure Water (Grade 1) for highly sensitive applications.

The systems are manufactured based on more than two decades of experience in laboratory water purification, using verified configurations of systems and high grade components and materials.

The systems are installable by user and all cartridges and filters are user-replaceable. The initial set of consumables is delivered with each of our water system.

Adrona water purification systems can be installed either on a laboratory bench or on a wall. Wallmount installation provides savings of valuable laboratory space.

The new Gradus, Connect LT and B300 systems are GLP compliant.

Purified water quality of all our water purification systems can be validated by an external conductometer with flow cell which can be ordered from Adrona or bought locally.

Conformity of the systems to their specifications is provided in case the systems are properly installed and maintained.

TOTAL ORGANIC CARBON (TOC) MONITOR

Organic contaminants may not have effect on conductivity of water, so conductivity sensors cannot be used for TOC monitoring. Therefore, a special TOC monitoring module is needed to measure TOC level. Several models of Adrona water purification systems have the TOC monitor feature. TOC values are shown on display.

COLOUR GRAPHIC LCD DISPLAY

The 16-bit colour display provides clear readout of water quality, system component status, performance of the polishing module. System component status is reflected on the display in an intuitive colour pattern (Green/Yellow/Red).



VOLUMETRIC DISPENSE

Depending on a model, Adrona water purification systems feature a volumetric dispenser, which enables the user to set accurate dispensing volume for each dispense cycle. The dispense volume can be set either from the keyboard or by using “teaching” mode. In “teaching” mode user uses “Dispense On/OFF” button to do the first dispense cycle manually. Afterwards, the system will dispense exactly the same volume each time the user presses the dispense button again.

DISPLAYS

Provide clear water quality readout and information about the system status including current resistivity and remaining pre-filter service life.

LARGE TOUCHSCREEN

Simplified and detailed information in multiple languages. Alarms and alerts are visible on the main screen with a complete information on actions required. Monitoring the operation system.

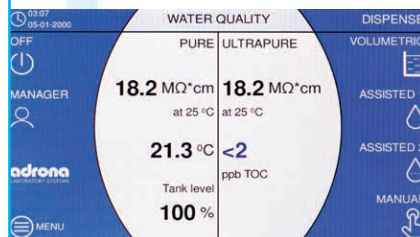

MONOCHROME HIGH RESOLUTION LCD DISPLAY



WATER QUALITY AND VALIDATION

Embedded recirculation loop ensures stable premium water quality and enables practical elimination of Total Organic Carbon (TOC).

Performance of deionization and polishing modules is constantly monitored. Monitoring algorithm enables cutting running costs, as replacement of the modules is requested only when service life is close to the end.

Water quality stability is achieved with the double Ion Exchange cartridge system, which ensures excellent water quality even if one of the cartridges needs to be replaced.

System flowchart shows all component status and water quality parameters at a glance. Image can vary depending on model and its configuration.

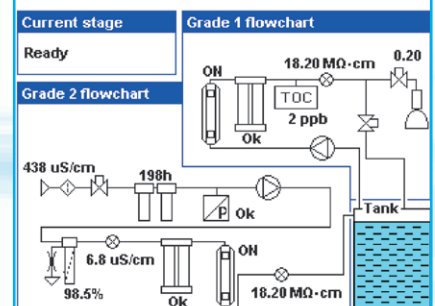

ELECTRODEIONIZATION MODULE

For laboratories with high water consumption Adrona offers Q-Front, RADIX or Gradus systems with an integrated EDI module. It allows to significantly reduce the running costs of water purification system due to EDI module which does not require replacement.

SAFETY

Adrona water purification systems feature all necessary safety functions. They are tested by an independent and accredited company for compliance with the CE directives related to safety and electromagnetic compatibility.

WARRANTY AND AFTER-SALES SUPPORT

Adrona provides 2 year warranty and continuous support. High customer satisfaction is our top priority in every aspect of business. Adrona's support has been greatly appreciated by dealers worldwide for its reliability and willingness to help. Continuously having all spare parts in stock enables us to guarantee short reaction times and quickly resolve any technical issues. Our support team is always ready to assist and in urgent cases dispatch the necessary components. Required repairs or technical maintenance is carried out

by appropriately trained local personal or Adrona's service engineers. In addition to spare parts, we ensure the availability of all consumables for the lifetime of every water purification system installed.

CERTIFICATION

ADRONA management system and manufacturing site operates in accordance with ISO 9001:2015. We are certified for manufacture, sale, and service of laboratory equipment.

CONFIGURATIONS ACCORDING TO APPLICATIONS

Each Adrona model is available in various configurations according to the customer needs.

Water for laboratory needs		RO	Grade 2		Grade 1		
Applications		RO	Pure	EDI	Trace	HPLC/LT	Bio
General laboratory applications	Glassware rinsing	•	•	•	•	•	•
	Laboratory washers	•	•	•	•	•	•
	Autoclaves	•	•	•	•	•	•
	Electrochemistry		•	•	•	•	•
	Wet chemistry		•	•	•	•	•
	Spectrophotometry		•	•	•	•	•
	Buffer and media preparation		•	•	•	•	•
	Reagent preparation		•	•	•	•	•
Inorganic analysis methods	Flame atomic absorption spectrophotometry		•	•	•	•	•
	Graphite automizer atomic absorption spectrophotometry				•	•	•
	Plasma mass-spectrometry (ICP-MS)				•	•	•
	Plasma spectrophotometry (ICP-OES)				•	•	•
	Ion chromatography				•	•	•
Organic analysis methods	Liquid chromatography (HPLC/ UHPLC)					•	•
	HPLC-MS					•	•
	Total organic carbon measurements					•	•
Molecular Biology	Flow cytometry						•
	Cell and tissue culture						•
	Molecular biology						•

GRADUS

Fully integrated pure and ultrapure intelligent water system. Superior quality of ultrapure and pure water is achieved directly from a tap water source.

Available in 2 configurations – deionization or EDI.

PRE-CLEAN PACK

High efficiency removal of colloids, particles, free chlorine and minerals for improved system performance.

EDI MODULE OR DI PACK

Removes remaining ions for consistently superior quality pure water. EDI system requires no maintenance, ensuring low and predictable costs.

ADVANCED REVERSE OSMOSIS (RO)

Removes 97-99% contaminants including ions, particles, bacteria and organic molecules, reduces feed water consumpt for 60%.

PRIOR TO WATER PRODUCTION

automatic rinsing of the RO membrane and the EDI module ensures that only the highest quality pure water enters the tank.



Attached G1 ultrapure water dispenser — delivers consistently ion free and low TOC ultrapure Grade 1 water.

Attached G2 pure water dispenser – delivers guaranteed quality Grade 2 pure water.

Within the tank, pure water quality is preserved by two built in features:

- Vent filter - provides protection against airborne contaminants
- Automatic Sanitization Module – with an integrated UVC regularly irradiates stored water and tank walls, preventing bacterial growth and biofilm formation.

Automatic recirculation of stored water through bactericidal UV lamp preserves water quality in the tank and ensures that high quality Grade 2 water is always on hand ready to use.

Ultra Pack Polishing Cartridge – removes ions and organic contaminants down to trace level.

Oxidation UV lamp – emitting 185 nm, photo-oxidises organic contaminants.

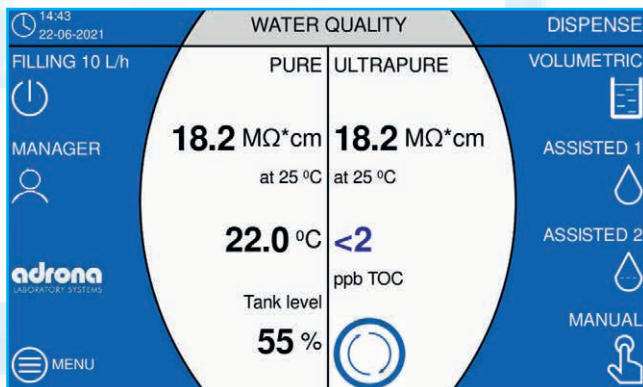

INTUITIVE TOUCHSCREEN DISPLAY

- New electronics and software.
- 7" colour touchscreen.
- USB and Ethernet interface.
- Data storage on USB-C stick.
- Dispense report preparation.
- Monitoring the operation of the system.
- Touchscreen is suitable for use with gloves.
- Alerts and alarms are displayed on the main screen with a complete description of actions required.

SPECIFICATIONS

	Trace (EDI)	LT (EDI)	Bio (EDI)
Grade 1 water resistivity at 25 °C	18.2 MΩ x cm	18.2 MΩ x cm	18.2 MΩ x cm
Grade 1 water conductivity at 25 °C	0.055 μS/ cm	0.055 μS/ cm	0.055 μS/ cm
Grade 2 water conductivity at 25 °C	0.1 ... 0.2 μS/cm	0.1 ... 0.2 μS/cm	0.1 ... 0.2 μS/cm
TOC	< 10 ppb	<3 ppb*	<3 ppb*
RNase	-	-	< 0.01 ng/mL
DNase	-	-	< 4 pg/μL
Bacteria	<0.01 CFU/mL	<0.01 CFU/mL	<0.01 CFU/mL
Endotoxins	<0.15 EU/mL	<0.15 EU/mL	<0.001 EU/mL
Particles >0.22 μm	<1/ per mL	<1/ per mL	<0.05/ per mL
Nominal flow to storage tank	3/5/10/15 L/h**		
Volumetric dispense	0.01 L to 100 L***		
Adjustable dispense rate	From 2 L/min to drop-by-drop		
Dimensions (WxDxH), cm	50(33)x45x63		

* In appropriate operating conditions <2 ppb, otherwise normally <3 ppb.

** Depends on the configuration.

*** Depends on the tank volume.

CONSUMABLES

Part number	Description	Replacement criteria	Comments
10411	Pre-filter Q w/ quick connectors	If the filters are clogged or every 6 months	
10311	Deionization Q w/ quick connectors	Grade 2 water conductivity is > 0.5 μm/cm constantly or every 12 months	Not applicable for EDI configuration
10033	Polishing Q w/ quick connectors	Grade 1 water conductivity is > 0.1 μm/cm constantly or every 12 months	Depends on water consumption amount
10017	Sterilization UV bulb	On average - every 2 years	"Bio" configuration
10018	Photooxidation UV bulb	On average - every 2 years	"LT" and "Bio" configuration
10012	Replacement 0.22 μm dispense filter	Every 6–12 months	"Trace" and "LT" configuration
10120	Replacement ultrafilter	Every 3–6 months	"Bio" configuration

ADJUSTABLE DISPENSE FLOW REGULATION

- Water delivered up to 2 liters per minute keeps interruptions to minimum.
- Volumetric dispense allows fast reissue of set volumes.
- Volumetric control is available from 0.01 to 100 L.
- Drop-by-drop function.

CONVENIENT

- Installation process gives quick access to laboratory water.
- Simple and trouble-free replacement of consumables.
- Built-in calibration of conductivity sensors.

COST-EFFECTIVE

- All consumables included.
- Large volume deionization (DI) cartridge.
- Space-saving design for a more efficient laboratory setup and daily operation.

FLOW DIAGRAM

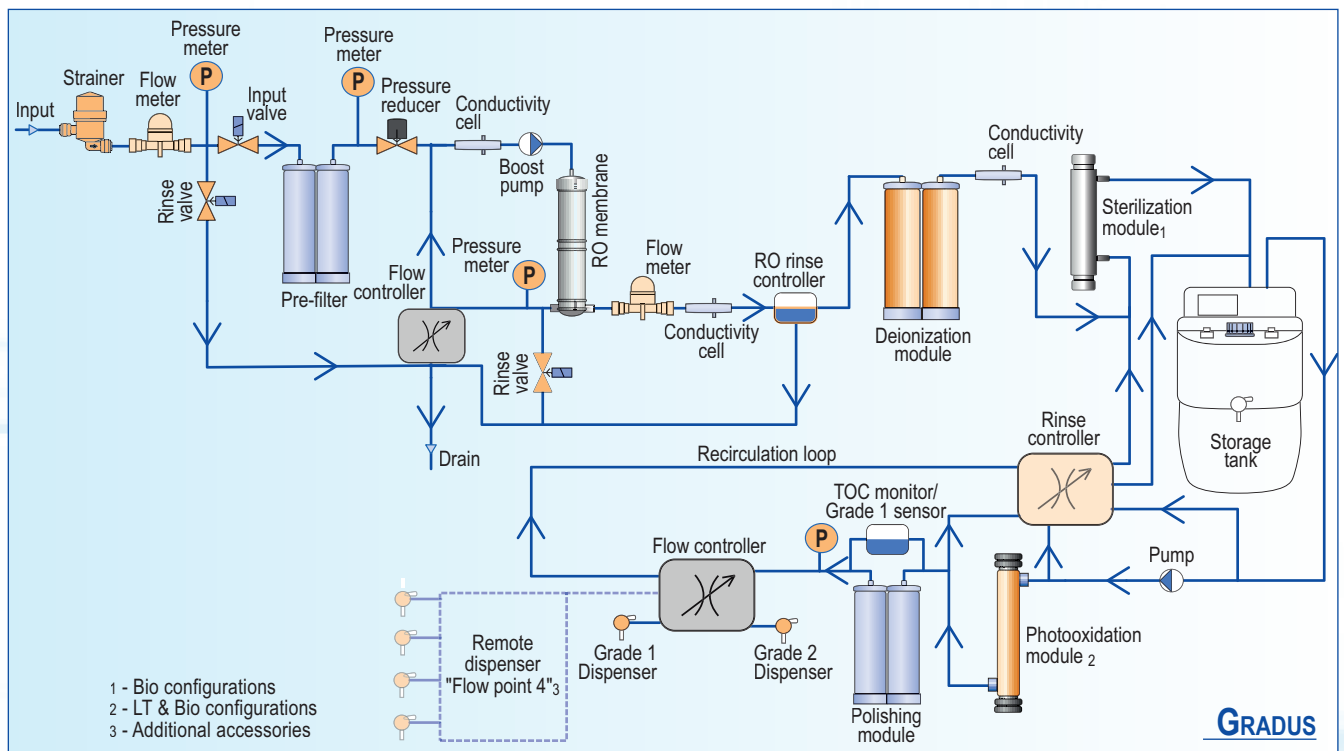

FLOW DIAGRAM

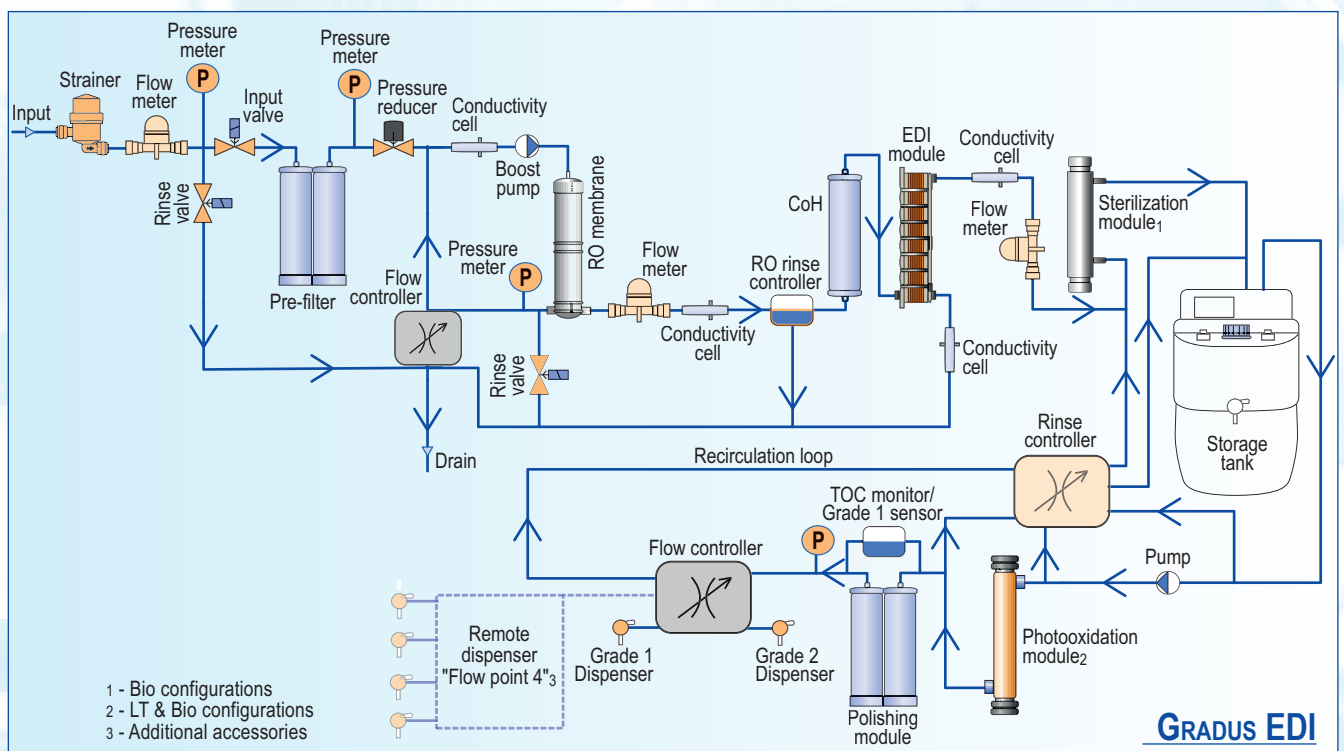



B300 & B310

The B300 is a new integrated Grade 2/Grade 1 laboratory water system, replacing the customer-approved previous B30 model.

The B310 is an extended version of the B300, which is designed to produce all types of Grade 2/ Grade 1 and RO laboratory water.

The B310 special feature is the ability to produce large volumes of water at low cost for general laboratory applications – glassware washers, autoclaves, rinsing of laboratory materials, etc. A pressurised tank can be added for RO water storage.

Both systems have completely new electronics and software, providing several additional features:

- large colour touch screen,
- data logging capability,
- warning and alarm messages,
- a wide range of flow control options,
- the ability to connect multiple remote dispensers,
- Ethernet and USB interfaces,
- dispense report preparation,
- improved accuracy of conductivity and TOC measurements.

The systems also include RO water recirculation, which reduces tap water consumption.

ORDERING INFORMATION

Model	Part number
B300 Trace	CB-3301
B300 HPLC	CB-3303
B300 Bio	CB-3305
B310 HPLC	CB-3503
B310 Bio	CB-3505

CONSUMABLES

Part number	Description	Replacement criteria	Comments
10319	Pre-filter set	If the filters are clogged or every 6 months	
10311	Deionization Q w/ quick connectors	Grade 2 water conductivity is >0.5 µm/cm constantly or every 12 months	
10031	Polishing Q w/ quick connectors	Grade 1 water conductivity is > 0.1 µm/cm constantly or every 12 months	Depends on water consumption amount
10017	Sterilization UV bulb	On average – every 2 years	“Bio” configuration
10018	Photooxidation UV bulb	On average – every 2 years	“HPLC” and “Bio” configuration
10012	Replacement 0.22 µm dispense filter	Every 6–12 months	“Trace” and “HPLC” configuration
10120	Replacement ultrafilter	Every 3–6 months	“Bio” configuration

SPECIFICATIONS B300

	Trace	HPLC	Bio
Grade 1 water resistivity at 25 °C	18.2 MΩ x cm	18.2 MΩ x cm	18.2 MΩ x cm
Grade 1 water conductivity at 25 °C	0.055 μS/ cm	0.055 μS/ cm	0.055 μS/ cm
Grade 2 water conductivity at 25 °C	<0.1 μS/cm	<0.1 μS/cm	<0.1 μS/cm
TOC	< 10 ppb	<5 ppb*	<5 ppb*
RNase	-	-	< 0.01 ng/mL
DNase	-	-	< 4 pg/μL
Bacteria	<0.01 CFU/mL	<0.01 CFU/mL	<0.01 CFU/mL
Endotoxins	<0.15 EU/mL	<0.15 EU/mL	< 0.001 EU/mL
Particles >0.22 μm	<1/ per mL	<1/ per mL	<0.05/ per mL
Nominal flow to storage tank	10 L/h		
Volumetric dispense	0.01 L to 100 L**		
Dispense rate, ultrapure water	1.5 - 2 L/min	1.5 - 2 L/min	1.5 - 2 L/min
Dimensions (WxDxH), cm	35x39x54	35x39x54	35x39x54
System weight, kg	27	28	29
Operation weight, kg	30	31	32

* In appropriate operating conditions <2 ppb, otherwise normally <5 ppb.

** Depends on the tank volume.

SPECIFICATIONS B310

	HPLC	Bio
Grade 1 water resistivity at 25 °C	18.2 MΩ x cm	18.2 MΩ x cm
Grade 1 water conductivity at 25 °C	0.055 μS/ cm	0.055 μS/ cm
Grade 2 water conductivity at 25 °C	<0.1 μS/cm	<0.1 μS/cm
TDS rejection rate	≥97%	≥97%
TOC	<5 ppb*	<5 ppb*
RNase	-	< 0.01 ng/mL
DNase	-	< 4 pg/μL
Bacteria	<0.01 CFU/mL	<0.01 CFU/mL
Endotoxins	<0.15 EU/mL	< 0.001 EU/mL
Particles >0.22 μm	<1/ per mL	<0.05/ per mL
Nominal flow to storage tank	10 L/h	
Volumetric dispense	0.01 L to 100 L**	
Dispense rate, ultrapure water	1.5 - 2 L/min	1.5 - 2 L/min
Dimensions (WxDxH), cm	35x39x54	35x39x54
System weight, kg	28	29
Operation weight, kg	31	32

* In appropriate operating conditions <2 ppb, otherwise normally <5 ppb.

** Depends on the tank volume.

FLOW DIAGRAM

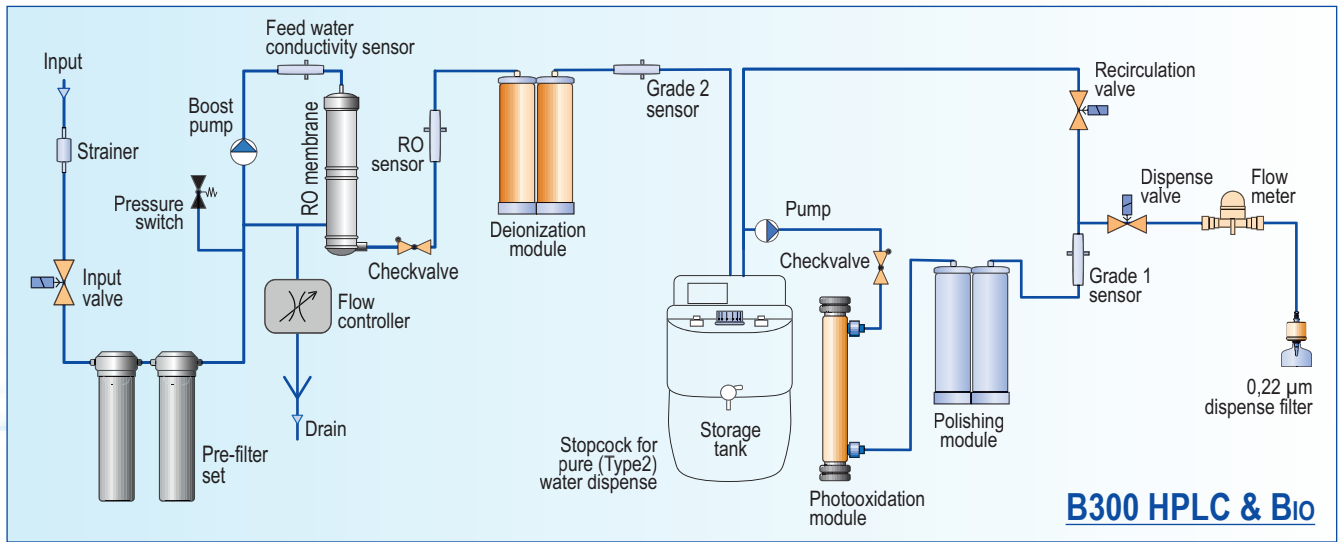

FLOW DIAGRAM

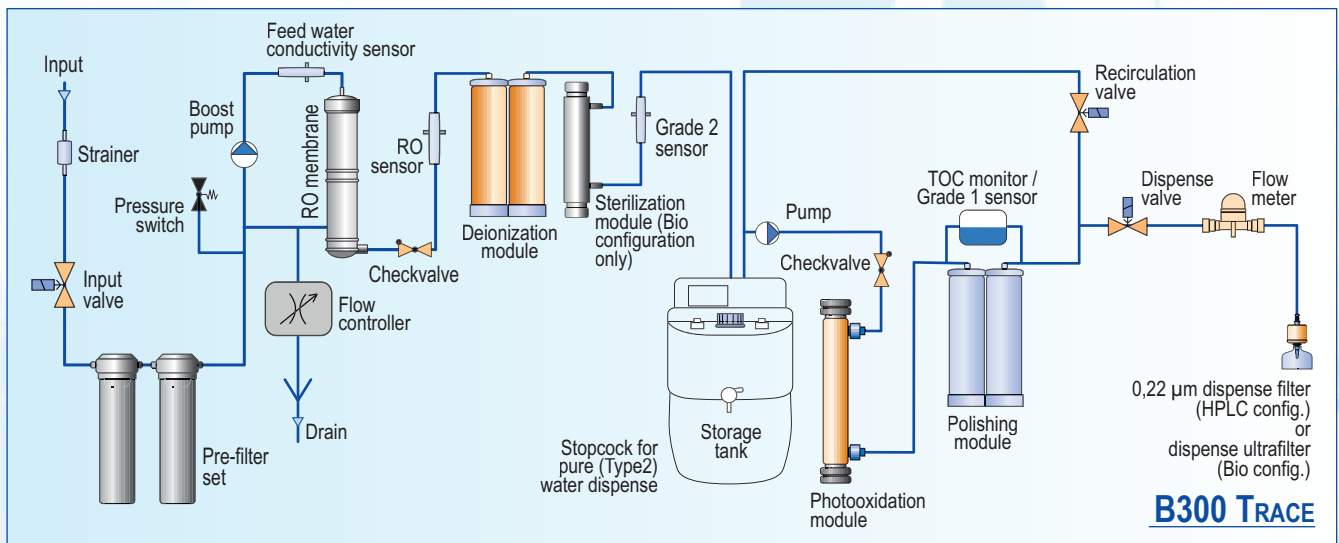

FLOW DIAGRAM

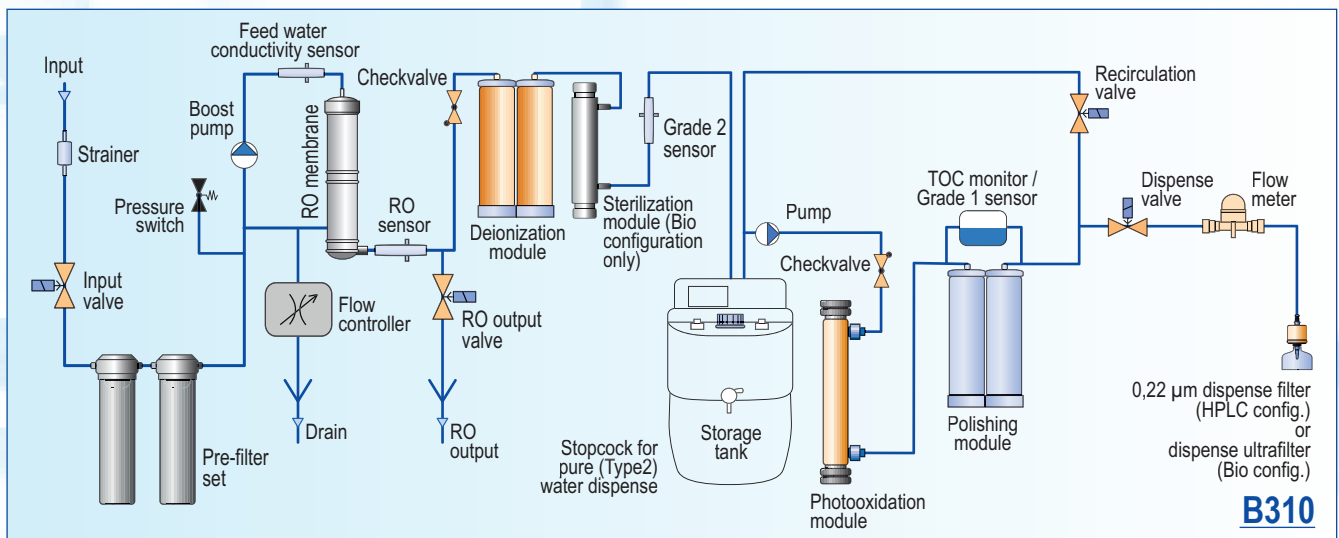

Q-FRONT N

Q-Front N is an excellent choice for your laboratory, providing both Grade 1 and Grade 2 water directly from tap water.

With Q-Front N series we have introduced new tool-free quick connectors for effortless cartridge replacement and a redesigned flexible dispenser, ensuring ergonomic and convenient daily operation.

Like the other Adrona water purification systems, Q-Front N is available in Trace, HPLC and Bio configurations to meet the specific needs of every laboratory and application.



CONSUMABLES

Part number	Description	Replacement criteria	Comments
10411	Pre-filter Q w/ quick connectors	If the filters are clogged or every 6 months	
10311	Deionization Q w/ quick connectors	Grade 2 water conductivity is > 0.5 µm/cm constantly or every 12 months	
10031	Polishing Q w/ quick connectors	Grade 1 water conductivity is > 0.1 µm/cm constantly or every 12 months	
10017	Sterilization UV bulb	2 years on average	"Bio" configuration
10018	Photooxidation UV bulb	2 years on average	"HPLC" and "Bio" configuration
10012	Replacement 0.22 µm dispense filter	Every 6–12 months	"Trace" and "HPLC" configuration
10120	Replacement ultrafilter	Every 3–6 months	"Bio" configuration

WATER QUALITY SPECIFICATIONS BY Q-FRONT N

	Trace	HPLC	Bio
Grade 1 water resistivity at 25 °C	18.2 MΩ x cm	18.2 MΩ x cm	18.2 MΩ x cm
Grade 1 water conductivity at 25 °C	0.055 µS/cm	0.055 µS/cm	0.055 µS/cm
Grade 2 water resistivity at 25 °C	>10 MΩ x cm	>10 MΩ x cm	>10 MΩ x cm
Grade 2 water conductivity at 25 °C	<0.1 µS/cm	<0.1 µS/cm	<0.1 µS/cm
Total Organic Carbon (TOC) level	<10 ppb	<5 ppb*	<5 ppb*
RNase	-	-	<0.01 ng/mL
DNase	-	-	<4 pg/µL
Bacteria	<0.01 CFU/mL	<0.01 CFU/mL	<0.01 CFU/mL
Endotoxins	<0.15 EU /mL	<0.15 EU /mL	<0.001 EU /mL
Particles >0.22 µm	<1/ per mL	<1/ per mL	<0.05/ per mL
Nominal flow, pure water (to storage tank)	10 L/h	10 L/h	10 L/h
Dispense rate, ultrapure water	1.5–2 L/min	1.5–2 L/min	1.5–2 L/min

* In appropriate operating conditions <2 ppb, otherwise normally <5 ppb.

ORDERING INFORMATION

Model	Part number
Q-Front N Trace	QF-2301
Q-Front N HPLC	QF-2303
Q-Front N Bio	QF-2305

DESCRIPTION

	Q-Front N Trace	Q-Front N HPLC	Q-Front N Bio
Q-Front N water type	<ul style="list-style-type: none"> ultrapure water (Grade 1) pure water (Grade 2) 	<ul style="list-style-type: none"> ultrapure water (Grade 1) pure water (Grade 2) 	<ul style="list-style-type: none"> ultrapure water (Grade 1) pure water (Grade 2)
Application	<ul style="list-style-type: none"> atomic absorption spectrometry plasma optical emission spectrometry other inorganic trace analysis 	<ul style="list-style-type: none"> chromatography mass spectrometry microbiology molecular biology 	<ul style="list-style-type: none"> highly sensitive molecular biology cell culture other methods sensitive to RNase and endotoxins biology applications
Display	colour graphic LCD display		
Water quality sensor	•	•	•
TOC Monitor	-	•	•
Volumetric dispense	•	•	•
Dispenser	flexible dispenser attached		
Connection to Flow point	•	•	•
Storage tank	storage tank required, but not included		
Installation	installable on a laboratory bench		

FLOW DIAGRAM

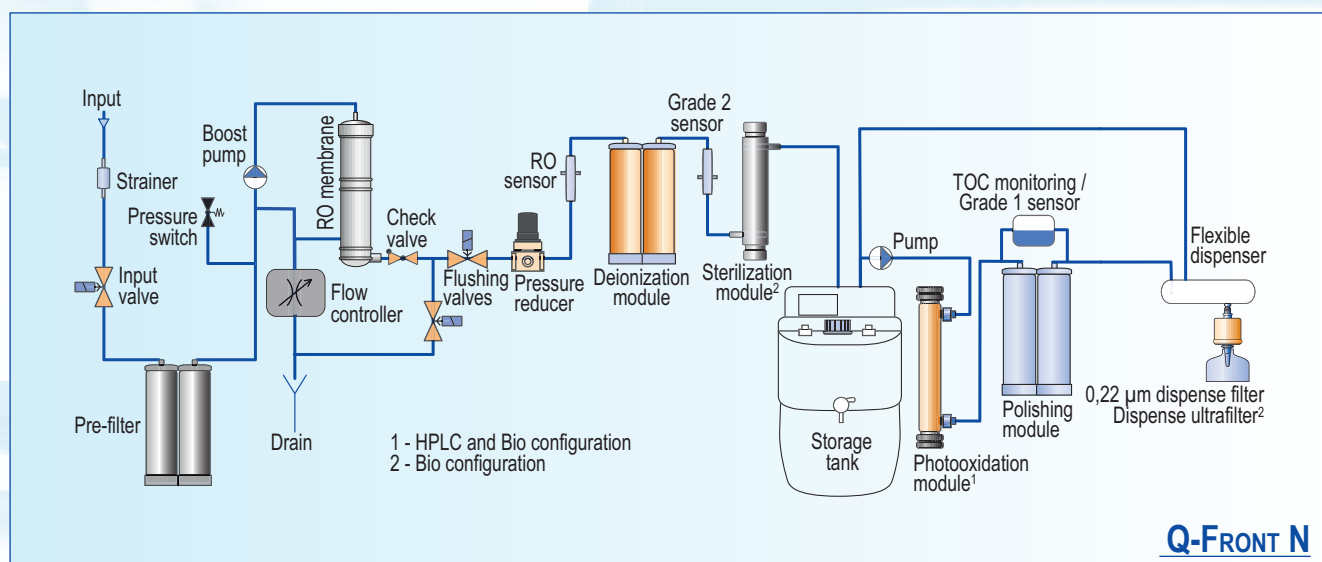

Q-FRONT

Adrona's products Q-Front 5/10 are ultrapure water systems in which water deionization and polishing are provided by one ion exchange cartridge. It simplifies servicing of the system and decreases the unit cost.

RO permeate water is stored in the tank and delivered to polishing loop by the pump.

Grade 1 water can be dispensed by attached dispenser. It includes volumetric dispense function. All well-known Grade 1 systems configurations - Trace, HPLC and Bio are available.



DESCRIPTION

	Q-Front Trace	Q-Front HPLC	Q-Front Bio
Q-Front water type	<ul style="list-style-type: none"> ultrapure water (Grade 1) RO water 	<ul style="list-style-type: none"> ultrapure water (Grade 1) RO water 	<ul style="list-style-type: none"> ultrapure water (Grade 1) RO water
Application	<ul style="list-style-type: none"> atomic absorption spectrometry plasma optical emission spectrometry other inorganic trace analysis 	<ul style="list-style-type: none"> chromatography mass spectrometry microbiology molecular biology 	<ul style="list-style-type: none"> highly sensitive molecular biology cell culture other methods sensitive to RNase and endotoxins biology applications
Display	colour graphic LCD display		
Water quality sensor	•	•	•
TOC Monitor	-	•	•
Volumetric dispense	•	•	•
Dispenser	flexible dispenser attached		
Connection to Flow point	•	•	•
Storage tank	storage tank required, but not included		
Installation	installable on a laboratory bench		

CONSUMABLES

Part number	Description	Replacement criteria	Comments
10410	Replacement pre-filter	If the filters are clogged or every 6 months	
10030	"Polishing+" module	Grade 1 water conductivity is > 0.1 µm/cm constantly or every 12 months	
10017	Sterilization UV bulb	2 years on average	"Bio" configuration
10018	Photooxidation UV bulb	2 years on average	"HPLC" and "Bio" configuration
10012	Replacement 0.22 µm dispense filter	Every 6–12 months	"Trace" and "HPLC" configuration
10120	Replacement ultrafilter	Every 3–6 months	"Bio" configuration



ORDERING INFORMATION

Model	Part number
Q-Front 5 Trace	QF-3101
Q-Front 10 Trace	QF-3201
Q-Front 5 HPLC	QF-3103
Q-Front 10 HPLC	QF-3203
Q-Front 5 Bio	QF-3105
Q-Front 10 Bio	QF-3205

SPECIFICATIONS

	Q-Front system configuration		
	Trace	HPLC	Bio
Grade 1 water resistivity at 25 °C	18.2 MΩ x cm	18.2 MΩ x cm	18.2 MΩ x cm
Grade 1 water conductivity at 25 °C	0.055 μS/cm	0.055 μS/cm	0.055 μS/cm
TDS rejection rate	≥97%	≥97%	≥97%
Total Organic Carbon (TOC) level	<10 ppb	<5 ppb*	<5 ppb*
RNase	-	-	<0.01 ng/mL
DNase	-	-	<4 pg/μL
Bacteria	<0.01 CFU/mL	<0.01 CFU/mL	<0.01 CFU/mL
Endotoxins	<0.15 EU /mL	<0.15 EU /mL	<0.001 EU /mL
Particles >0.22 μm	<1/mL	<1/mL	<0.05/ per mL
Feed water pressure	0.4 - 6 bar	0.4 - 6 bar	0.4 - 6 bar
Data interface	RS 232	RS 232	RS 232
Dimensions (WxDxH), cm	35x39x54	35x39x54	35x39x54
System weight, kg	25	26	27
Operation weight, kg	28	29	30

* In appropriate operating conditions <2 ppb, otherwise normally <5 ppb.

FLOW DIAGRAM

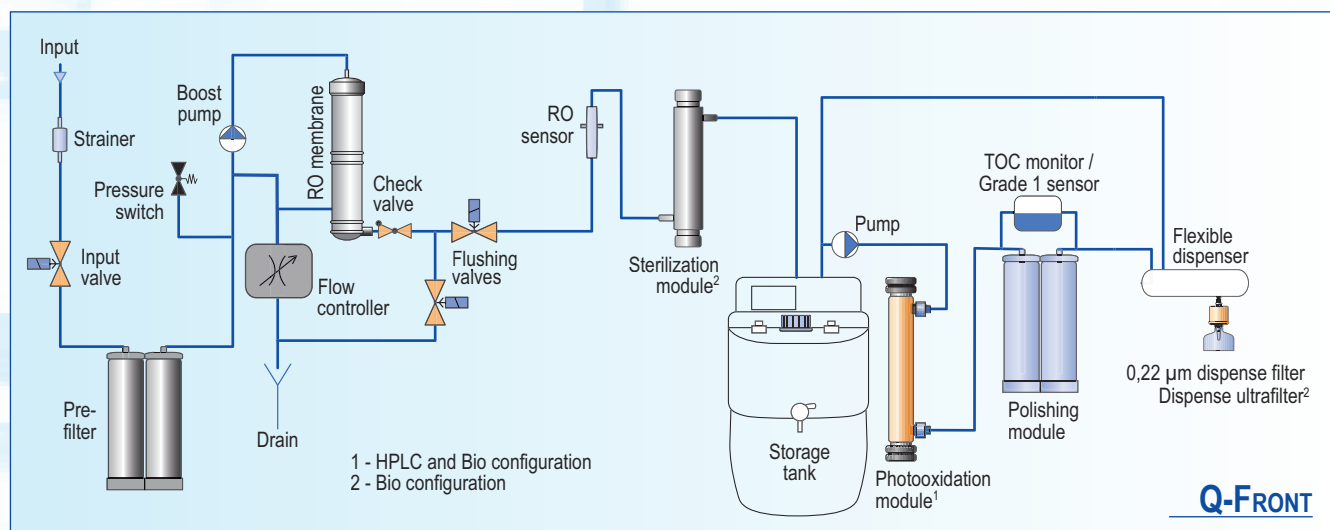

Q-FRONT EDI

Adrona's product Q-Front EDI is a tap water system for general laboratory applications and inorganic analytical methods. Q-Front EDI systems are intended for use in laboratories with high daily pure and ultrapure water consumption. Q-Front EDI systems include the flexible dispenser.



DESCRIPTION

	Q-Front EDI Trace	Q-Front EDI HPLC	Q-Front EDI Bio
Q-Front EDI water type	<ul style="list-style-type: none"> ultrapure water (Grade 1) pure water (Grade 2) 	<ul style="list-style-type: none"> ultrapure water (Grade 1) pure water (Grade 2) 	<ul style="list-style-type: none"> ultrapure water (Grade 1) pure water (Grade 2)
Application	<ul style="list-style-type: none"> atomic absorption spectrometry plasma optical emission spectrometry other inorganic trace analysis 	<ul style="list-style-type: none"> chromatography mass spectrometry microbiology molecular biology 	<ul style="list-style-type: none"> highly sensitive molecular biology cell culture other methods sensitive to RNase and endotoxins biology applications
Display	colour graphic LCD display		
Water quality sensor	•	•	•
TOC Monitor	-	•	•
Volumetric dispense	•	•	•
Dispenser	flexible dispenser attached		
Connection to Flow point	•	•	•
Storage tank	storage tank required, but not included		
Installation	installable on a laboratory bench		

CONSUMABLES

Part number	Description	Replacement criteria	Comments
10410	Replacement pre-filter	If the filters are clogged or every 6 months	
10030	"Polishing+" module	Grade 1 water conductivity is > 0.1 µm/cm constantly or every 12 months	
10017	Sterilization UV bulb	2 years on average	"Bio" configuration
10018	Photooxidation UV bulb	2 years on average	"HPLC" and "Bio" configuration
10012	Replacement 0.22 µm dispense filter	Every 6–12 months	"Trace" and "HPLC" configuration
10120	Replacement ultrafilter	Every 3–6 months	"Bio" configuration



ORDERING INFORMATION

Model	Part number
Q-Front 5 EDI Trace	QF-4101
Q-Front 10 EDI Trace	QF-4201
Q-Front 5 EDI HPLC	QF-4103
Q-Front 10 EDI HPLC	QF-4203
Q-Front 5 EDI Bio	QF-4105
Q-Front 10 EDI Bio	QF-4205

SPECIFICATIONS

	Q-Front EDI system configuration		
	Trace	HPLC	Bio
Grade 1 water resistivity at 25 °C	18.2 MΩ x cm	18.2 MΩ x cm	18.2 MΩ x cm
Grade 1 water conductivity at 25 °C	0.055 μS/cm	0.055 μS/cm	0.055 μS/cm
Grade 2 water conductivity at 25 °C	0.1 μS/cm	0.1 μS/cm	0.1 μS/cm
Total Organic Carbon (TOC) level	<10 ppb	<5 ppb*	<5 ppb*
RNase	-	-	<0.01 ng/mL
DNase	-	-	<4 pg/μL
Bacteria	<0.01 CFU/mL	<0.01 CFU/mL	<0.01 CFU/mL
Endotoxins	<0.15 EU /mL	<0.15 EU /mL	<0.001 EU /mL
Particles >0.22 μm	<1/mL	<1/mL	<0.05/ per mL
Feed water pressure	0.4 - 6 bar	0.4 - 6 bar	0.4 - 6 bar
Data interface	RS 232	RS 232	RS 232
Dimensions (WxDxH), cm	35x39x54	35x39x54	35x39x54
System weight, kg	27	28	29
Operation weight, kg	31	32	33

* In appropriate operating conditions <2 ppb, otherwise normally <5 ppb.

FLOW DIAGRAM

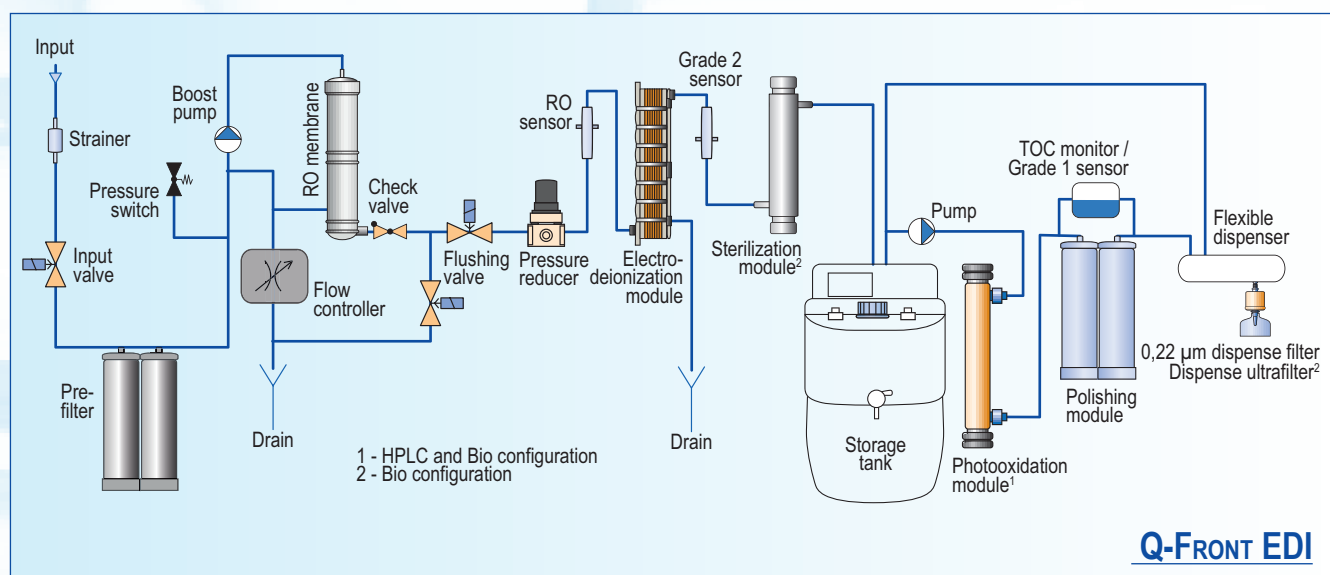

Q-FRONT EDI

Q-FRONT (EDI) PURE

The compact and user-friendly Q-Front (EDI) Pure systems are highly recommended as the pure water source in your laboratory, providing Grade 2 water for a wide range of general laboratory applications.

The Q-Front EDI Pure systems purify the incoming feed water by electrodeionization technology, which is the most cost-effective long-term solution due to reduced running costs, as no deionization cartridges have to be replaced.

The conventional Q-Front Pure system is equipped with deionization cartridge to obtain pure Grade 2 water.



SPECIFICATIONS

	Q-Front EDI Pure	Q-Front Pure
Grade 2 water resistivity at 25 °C	10.0 ... 5.0 MΩ x cm	
Grade 2 water conductivity at 25 °C	0.1 ... 0.2 μS/cm	
Particles >0.22 μm	<1/ per mL	
TOC	<30 ppb	
Nominal flow to storage tank	5 / 10 / 15 L/h	
Data interface	RS 232	
Dimensions (WxDxH), cm	35x39x54	
System weight, kg	16	14
Operation weight, kg	18	16
Feed water pressure	0.4 - 6 bar	

DESCRIPTION

	Q-Front EDI Pure	Q-Front Pure
Water type	pure water (Grade 2)	
Display	colour graphic LCD display	
Water quality sensor	•	•
TOC Monitor	-	-
Volumetric dispense	-	-
Dispenser	-	-
Connection to Flow point	-	-
Deionization technology	EDI	ion exchange
Storage tank	required, not included	
Installation	installable on a laboratory bench	

ORDERING INFORMATION

Model	Part number
Q-Front 5 EDI Pure	QF-4100
Q-Front 10 EDI Pure	QF-4200
Q-Front 15 EDI Pure	QF-4300
Q-Front 10 Pure	QF-3200

CONSUMABLES

Part number	Description	Replacement criteria	Comments
10410	Pre-filter module	If the filters are clogged or every 6 months	
10310	Deionization module	Grade 2 water conductivity is $>0.5 \mu\text{m/cm}$ constantly or every 12 months	Non-EDI configuration only
10017	Sterilization UV bulb	2 years on average	"Bio" configuration

FLOW DIAGRAM

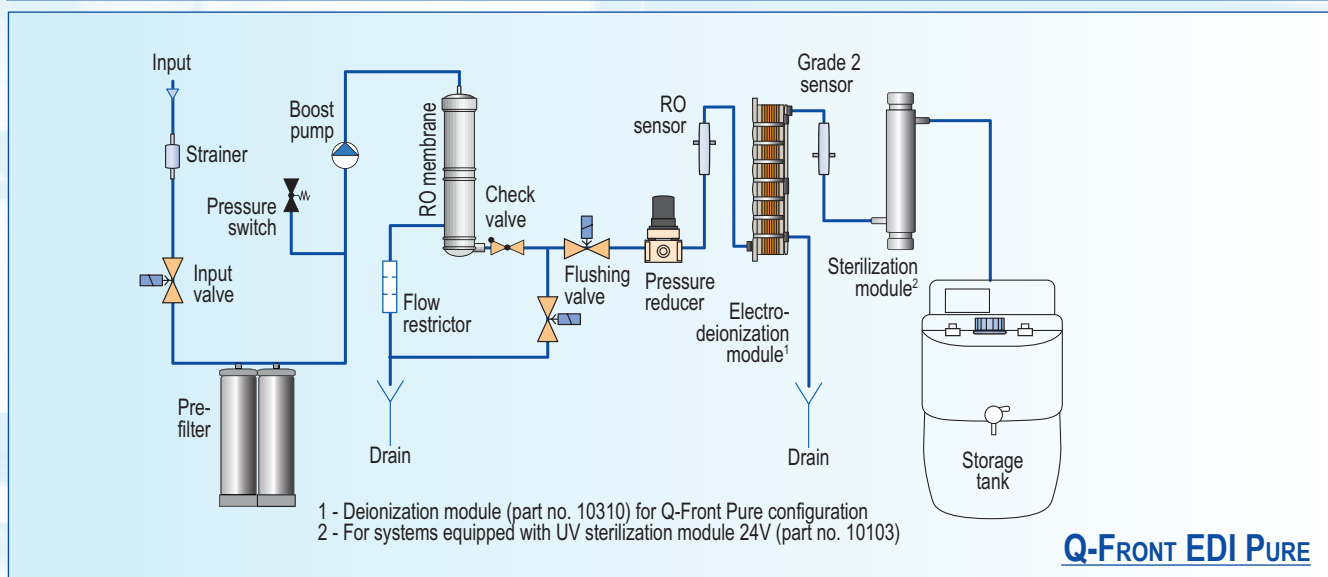

Q-FRONT EDI PURE

INTEGRITY+



The Integrity+ series water purification systems produce ultrapure water for laboratory needs directly from tap water. Integrity+ series systems contain a 5 L embedded tank to keep the system compact.

DESCRIPTION

	Integrity+ Trace	Integrity+ HPLC	Integrity+ Bio
Water type	ultrapure water (Grade 1)	ultrapure water (Grade 1)	ultrapure water (Grade 1)
Application	<ul style="list-style-type: none"> • atomic absorption spectrometry • plasma optical emission spectrometry • other inorganic trace analysis 	<ul style="list-style-type: none"> • chromatography • mass spectrometry • microbiology • molecular biology 	highly sensitive biology applications
Display	colour graphic LCD display		
Conductivity sensor	•	•	•
TOC Monitor	-	•	•
Measurement validation port	•	•	•
Volumetric dispensing	•	•	•
Storage tank	integrated tank 5L		
Installation	installable either on a laboratory bench or on a wall		

ORDERING INFORMATION

Model	Part number
Integrity+ Trace	CB-2101
Integrity+ HPLC	CB-2103
Integrity+ Bio	CB-2105

SPECIFICATIONS

	Integrity+ system configuration		
	Trace	HPLC	Bio
Grade 1 water resistivity at 25 °C	18.2 MΩ x cm	18.2 MΩ x cm	18.2 MΩ x cm
Grade 1 water conductivity at 25 °C	0.055 μS/cm	0.055 μS/cm	0.055 μS/cm
Grade 2 water conductivity at 25 °C	0.1 μS/cm	0.1 μS/cm	0.1 μS/cm
Total Organic Carbon (TOC) level	<10 ppb	<5 ppb*	<5 ppb*
RNase	-	-	<0.01 ng/mL
DNase	-	-	<4 pg/μL
Bacteria	<0.01 CFU /mL	<0.01 CFU /mL	<0.01 CFU /mL
Endotoxins	<0.15 EU /mL	<0.15 EU /mL	<0.001 EU /mL
Particles >0.22 μm	<1/mL	<1/mL	<0.05/mL
Dimensions (WxDxH), cm	32x56x62	32x56x62	32x56x62
System weight, kg	24	25	26
Operation weight, kg	32	33	34
Data interface	RS 232	RS 232	RS 232
Feed water pressure	2 – 6 bar	2 – 6 bar	2 – 6 bar

* In appropriate operating conditions <2 ppb, otherwise normally <5 ppb.

CONSUMABLES

Part number	Description	Replacement criteria	Comments
10319	Pre-filter set	If the filters are clogged or every 6 months	
10030	Polishing module "Polishing+"	Grade 1 water conductivity is > 0.1 µm/cm constantly or every 12 months	
10018	UV photooxidation bulb	2 years on average	Only for „Bio” and „HPLC”
10012	0.22 µm dispense filter	Every 6–12 months	Only for „Trace” and „HPLC”
10120	Replacement ultrafilter	Every 3–6 months	Only for „Bio”

FLOW DIAGRAMS

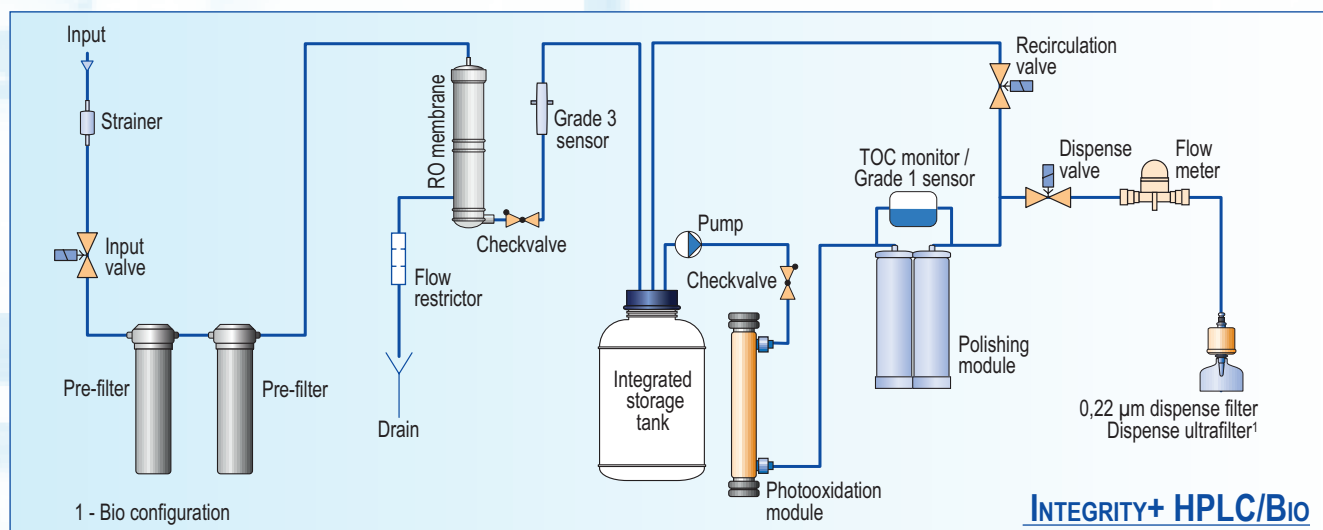
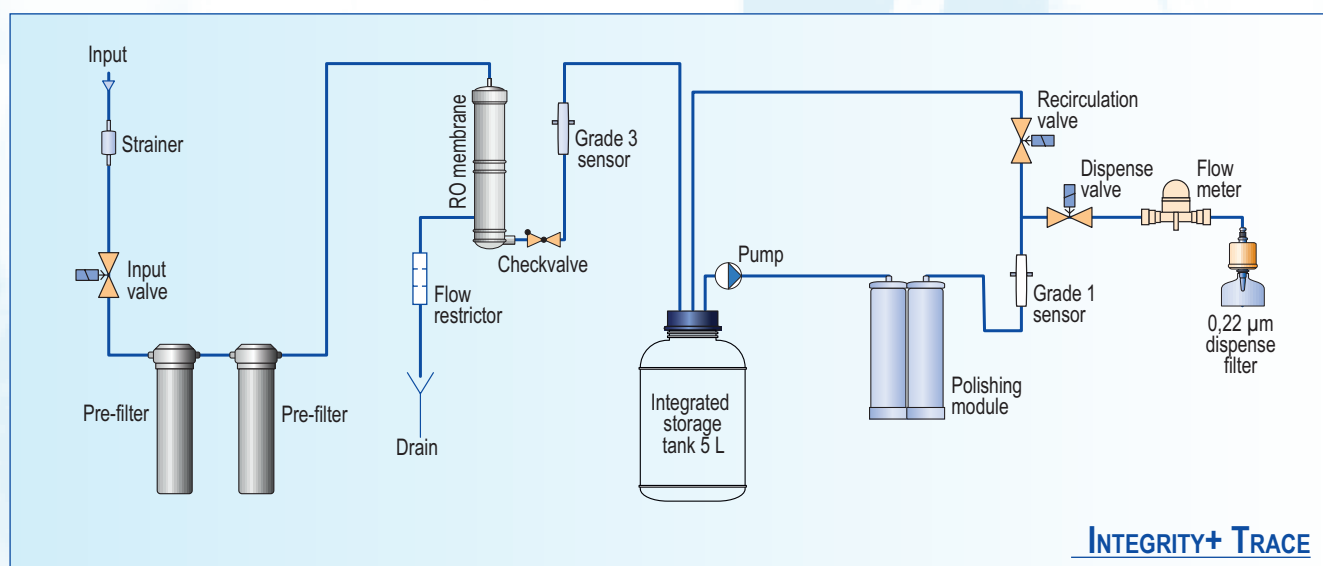

E30

E30 water purification system produce ultrapure and pure water for laboratory needs. It is designed for maximum convenience of use and to have maximum features. Is it a system with high price/performance ratio.

ORDERING INFORMATION

Model	Part number
E30 Trace	CE30-1001
E30 HPLC	CE30-1101
E30 Bio	CE30-1201



DESCRIPTION

	E30 Trace	E30 HPLC	E30 Bio
Water type	<ul style="list-style-type: none"> ultrapure water (Grade 1) pure water (Grade 2) 	<ul style="list-style-type: none"> ultrapure water (Grade 1) pure water (Grade 2) 	<ul style="list-style-type: none"> ultrapure water (Grade 1) pure water (Grade 2)
Application	<ul style="list-style-type: none"> atomic absorption spectrometry plasma optical emission spectrometry other inorganic trace analysis 	<ul style="list-style-type: none"> chromatography mass spectrometry microbiology molecular biology 	highly sensitive biology applications
Display	colour LCD display		
Conductivity sensor	•	•	•
TOC Monitor	-	•	•
Volumetric dispensing	•	•	•
Connection to Flow point	•	•	•
Storage tank	required but not included		
Installation	installable on a laboratory bench		

SPECIFICATIONS

	E30 Trace	E30 HPLC	E30 Bio
Grade 1 water resistivity at 25 °C	18.2 MΩ x cm	18.2 MΩ x cm	18.2 MΩ x cm
Grade 1 water conductivity at 25 °C	0.055 μS/cm	0.055 μS/cm	0.055 μS/cm
Grade 2 water conductivity at 25 °C	<0.1 μS/cm	<0.1 μS/cm	<0.1 μS/cm
Total Organic Carbon (TOC) level	<10 ppb	<5 ppb*	<5 ppb*
RNase	-	-	<0.01 ng/mL
DNase	-	-	<4 pg/μL
Bacteria	<0.01 CFU/mL	<0.01 CFU/mL	<0.01 CFU/mL
Endotoxins	<0.15 EU/mL	<0.15 EU/mL	<0.001 EU/mL
Particles >0.22 μm	<1 per mL	<1 per mL	<0.05/mL
Nominal flow, pure water (to storage tank)	10 L/h	10 L/h	10 L/h
Dimensions (WxDxH), cm	40x35x55	40x35x55	40x35x55
System weight, kg	17	18	19
Operation weight, kg	24	25	26
Feed water pressure	0.4- 6 bar	0.4- 6 bar	0.4- 6 bar
Feed water conductivity	< 1500 μS/cm	< 1500 μS/cm	< 1500 μS/cm

* In appropriate operating conditions <2 ppb, otherwise normally <5 ppb.

CONSUMABLES

Part number	Description	Replacement criteria	Comments
10320	Replacement pre-filter	If the filters are clogged or every 6 months	
10310	Replacement deionization module	Grade 2 water conductivity is > 0.5 $\mu\text{m}/\text{cm}$ constantly or every 12 months	
10030	Polishing module "Polishing+"	Grade 1 water conductivity is > 0.1 $\mu\text{m}/\text{cm}$ constantly or every 12 months	
10017	Replacement sterilization UV bulb	When required (on average every 2 years)	„Bio” systems only
10018	Replacement photooxidation UV bulb	2 years on average	„HPLC” and „Bio” systems only
10012	Replacement 0.22 μm dispense microfilter	Every 6–12 months	„Trace” and „HPLC” systems
10120	Replacement ultrafilter	Every 3–6 months	„Bio” systems only

FLOW DIAGRAMS

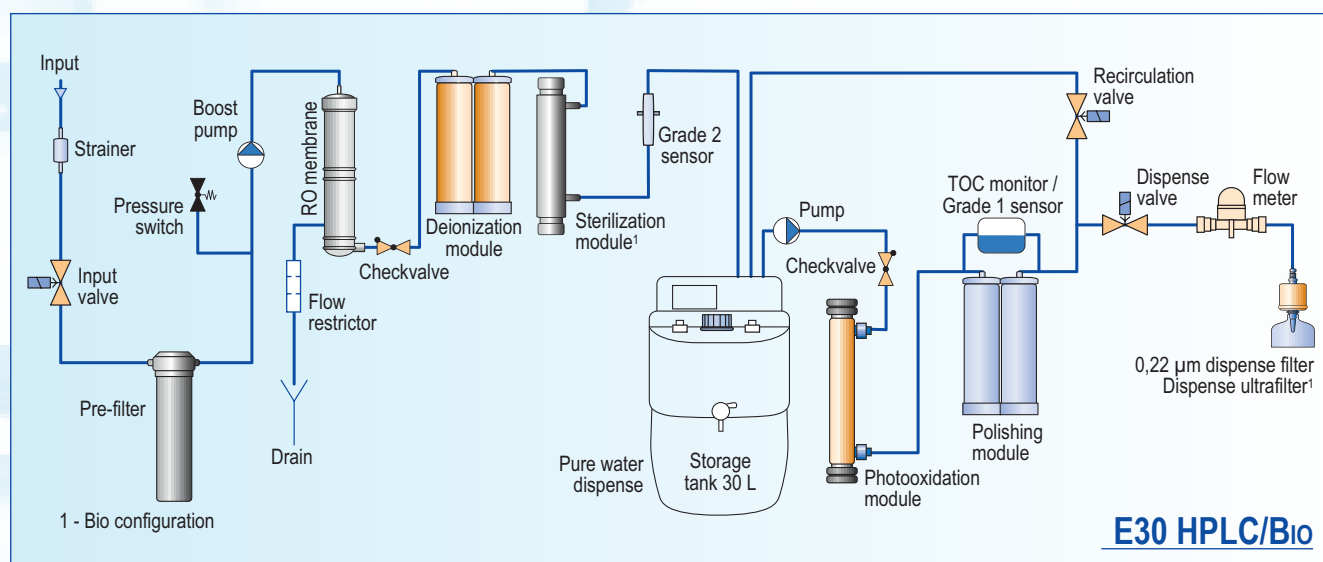
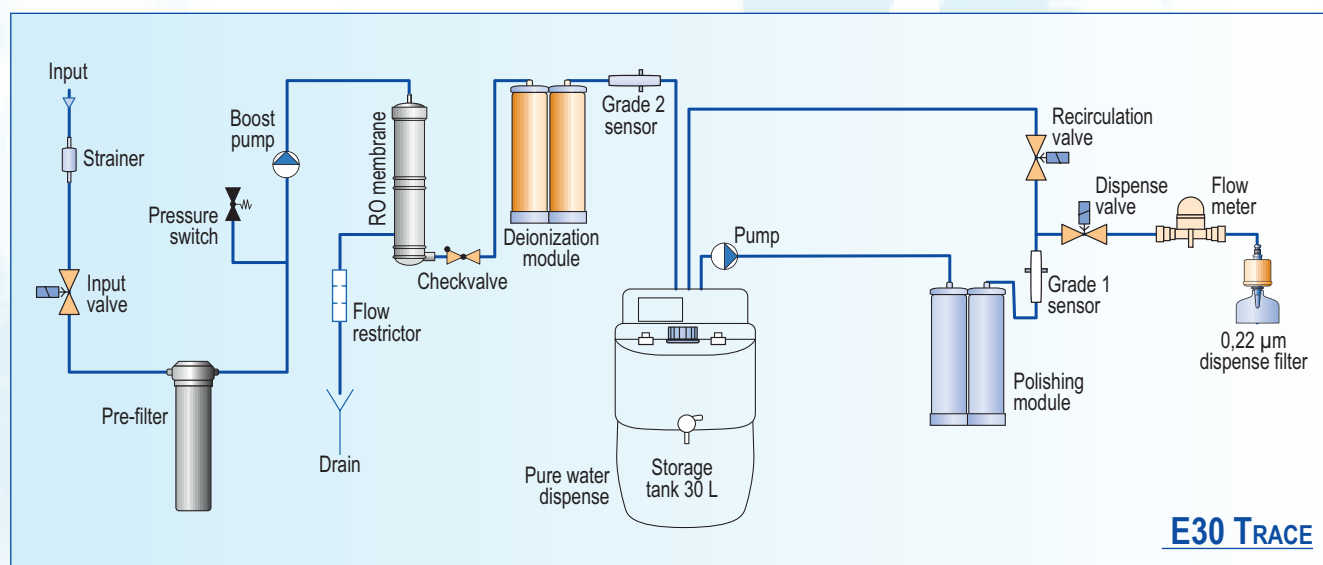

CRYSTAL EX

Adrona Crystal EX produces ultrapure and pure water. This multipurpose water purification system is highly appreciated due to the very affordable price.

ORDERING INFORMATION

Model	Part number
Crystal EX Trace	EX-1001
Crystal EX HPLC	EX-1101
Crystal EX Bio	EX-1201



CONSUMABLES

Part number	Description	Replacement criteria	Comments
10320	Replacement pre-filter	If the filters are clogged or every 6 months	
10310	Replacement deionization module	Grade 2 water conductivity is $> 0.5 \mu\text{m/cm}$ constantly or every 12 months	
10030	Polishing module "Polishing+"	Grade 1 water conductivity is $> 0.1 \mu\text{m/cm}$ constantly or every 12 months	
10017	Replacement sterilization UV bulb	When required (on average every 2 years)	„Bio” systems only
10018	Replacement photooxidation UV bulb	2 years on average	„HPLC” and „Bio” systems only
10012	Replacement $0.22 \mu\text{m}$ dispense microfilter	Every 6–12 months	„Trace” and „HPLC” systems
10120	Replacement ultrafilter	Every 3–6 months	„Bio” systems only

FLOW DIAGRAM

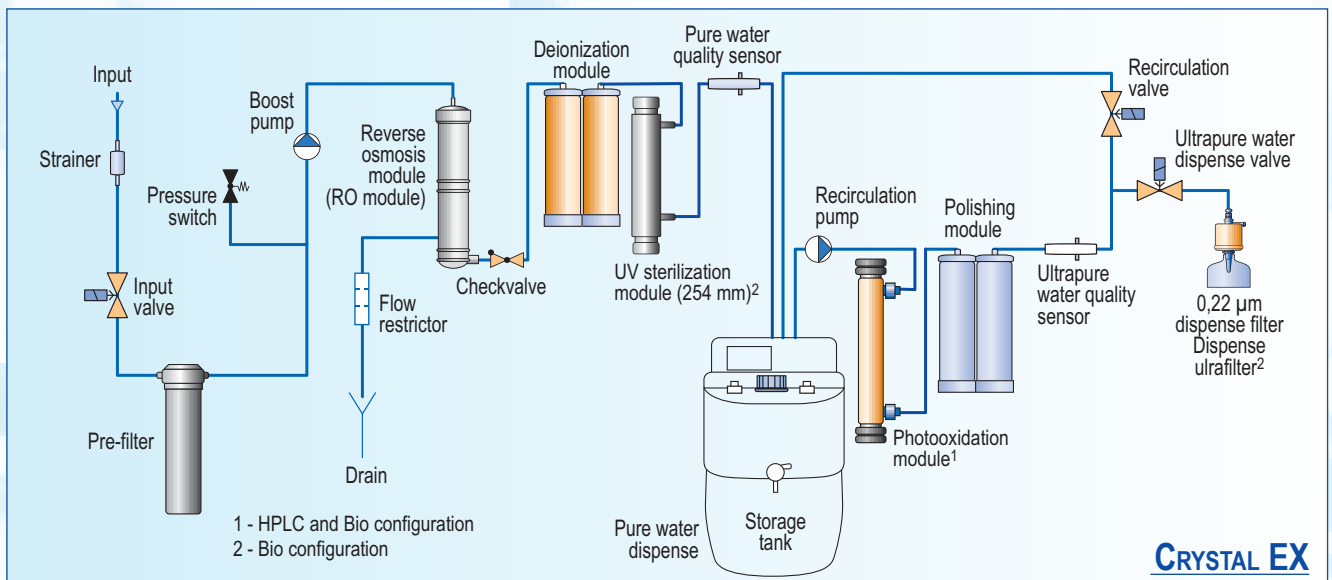

DESCRIPTION EX SERIES

	Trace	HPLC	Bio
Water type	<ul style="list-style-type: none"> ultrapure water (Grade 1) pure water (Grade 2) 	<ul style="list-style-type: none"> ultrapure water (Grade 1) pure water (Grade 2) 	<ul style="list-style-type: none"> ultrapure water (Grade 1) pure water (Grade 2)
Application	<ul style="list-style-type: none"> atomic absorption spectrometry plasma optical emission spectrometry other inorganic trace analysis 	<ul style="list-style-type: none"> chromatography mass spectrometry microbiology molecular biology 	highly sensitive biology applications
Display	Monochrome LCD display		
Conductivity sensor	•	•	•
TOC Monitor	-	-	-
Volumetric dispensing	-	-	-
Connection to Flow point	-	-	-
Storage tank	required but not included		
Installation	installable on a laboratory bench		

SPECIFICATIONS

	Crystal EX Trace	Crystal EX HPLC	Crystal EX Bio
Grade 1 water resistivity at 25 °C	18.2 MΩ x cm	18.2 MΩ x cm	18.2 MΩ x cm
Grade 1 water conductivity at 25 °C	0.055 μS/cm	0.055 μS/cm	0.055 μS/cm
Grade 2 water resistivity at 25 °C	>10 MΩ x cm	>10 MΩ x cm	>10 MΩ x cm
Grade 2 water conductivity at 25 °C	<0.1 μS/cm	<0.1 μS/cm	<0.1 μS/cm
Total Organic Carbon (TOC) level	<10 ppb	<5 ppb*	<5 ppb*
RNase	-	-	<0.01 ng/mL
DNase	-	-	<4 pg/μL
Bacteria	<0.01 CFU/mL	<0.01 CFU/mL	<0.01 CFU/mL
Endotoxins	<0.15 EU/mL	<0.15 EU/mL	<0.001 EU/mL
Particles >0.22 μm	<1 per mL	<1 per mL	<1 per mL
Nominal flow, pure water (to storage tank)	10 L/h	10 L/h	10 L/h
Dimensions (WxDxH), cm	40x35x55	40x35x55	40x35x55
System weight, kg	17	18	19
Operation weight, kg	24	25	26
Feed water pressure	0.4 – 4 bar	0.4 – 4 bar	0.4 – 4 bar
Feed water conductivity	< 1500 μS/cm	< 1500 μS/cm	< 1500 μS/cm

* In appropriate operating conditions <2 ppb, otherwise normally <5 ppb.

CRYSTAL EX PURE CRYSTAL EX DOUBLE FLOW CRYSTAL EX RO

Crystal EX RO and Pure systems produce pure (Grade 2) and RO water. Pure and RO water comply with the requirements of a variety of applications, including:

- many inorganic methods of analysis (e. g. flame AAS);
- wet chemistry methods;
- electrochemistry;
- labware washing, etc.

The water purification system Crystal Double Flow is specially designed for the laboratories and applications with high water consumption (30 L/day and more). The system includes a high capacity (8 L) deionization module, that provides a reduction of system running costs.



DESCRIPTION

	Crystal EX RO	Crystal EX Pure	Crystal EX Double Flow
Water type	RO water	pure water (Grade 2)	pure water (Grade 2)
Application	<ul style="list-style-type: none"> • wet chemistry methods • labware washing • steam sterilizers • polishers feed 	<ul style="list-style-type: none"> • flame spectrophotometry • inorganic analytical methods • electrochemistry • buffer preparation 	<ul style="list-style-type: none"> • flame spectrophotometry • inorganic analytical methods • electrochemistry • buffer preparation
Display	Monochrome LCD display		
Conductivity sensor	•	•	•
TOC Monitor	-	-	-
Measurement validation port	-	-	-
Volumetric dispensing	-	-	-
Connection to Flow Point	-	-	-
Storage tank	required but not included		
Installation	installable on a laboratory bench		

ORDERING INFORMATION

Model	Part number
Crystal EX RO	EX-1245
Crystal EX Pure	EX-1005
Crystal EX Double Flow	EX20-1002HC
Crystal EX Pure 4	EX-1004

SPECIFICATIONS

	Crystal EX RO	Crystal EX Pure	Crystal EX Double Flow
Purified water resistivity at 25 °C	-	>10 MΩ x cm	>10 MΩ x cm
Purified water conductivity at 25 °C	TDS rejection rate ≥97%	<0.1 μS/cm	<0.1 μS/cm
Particles >0.22 μm	<1 per mL	<1 per mL	<1 per mL
Nominal flow, pure water (to storage tank)	10 L/h	10 L/h	20 L/h
Dimensions (WxDxH), cm	40x35x55	40x35x55	40x50x55
System weight, kg	10	12	26
Operation weight, kg	13	16	39
Feed water pressure	0.4 – 4 bar	0.4 – 4 bar	0.4 – 4 bar
Feed water conductivity	< 1500 μS/cm	< 1500 μS/cm	< 1500 μS/cm

CONSUMABLES

Part number	Description	Replacement criteria	Comments
10320	Replacement pre-filter	If the filters are clogged or every 6 months	“RO” and “Pure” systems only
10410	Replacement pre-filter module	If the filters are clogged or every 6 months	“EX Double Flow” system only
10310	Replacement deionization module	Grade 2 water conductivity is >0.5 μm/cm constantly or every 12 months	“Pure” systems only
10113	Replacement high-capacity deionization module	Grade 2 water conductivity is >0.5 μm/cm constantly or every 12 months	“EX Double Flow” only
10017	Replacement sterilization UV bulb	As required (on average every 2 years)	Only systems with 10103 option

FLOW DIAGRAMS

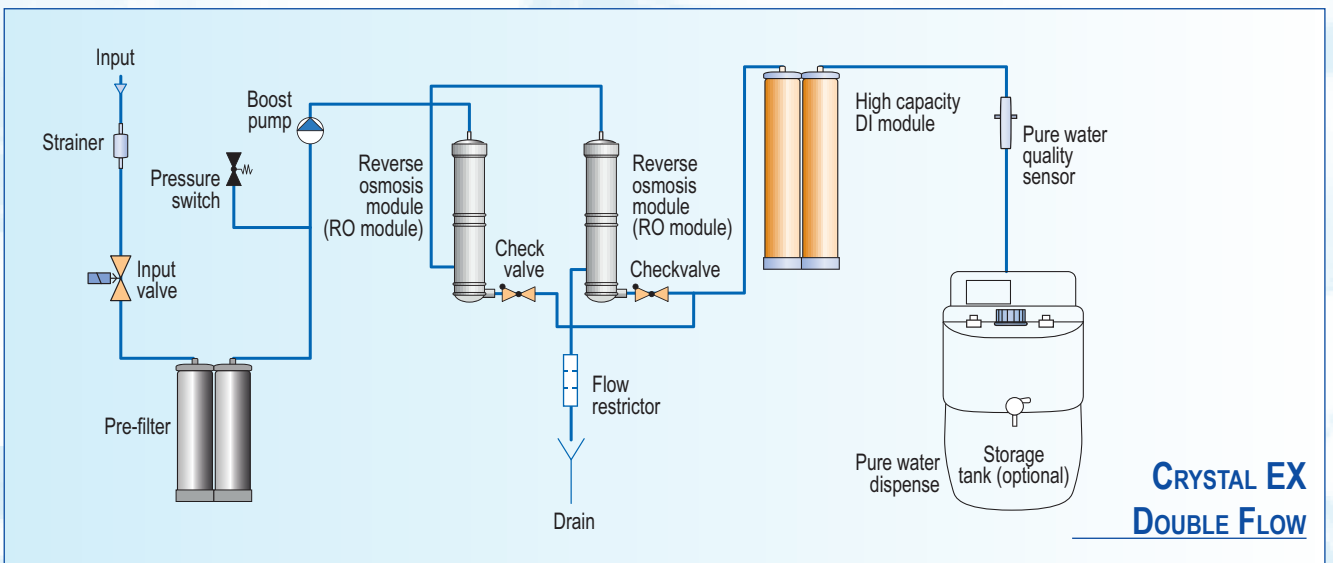
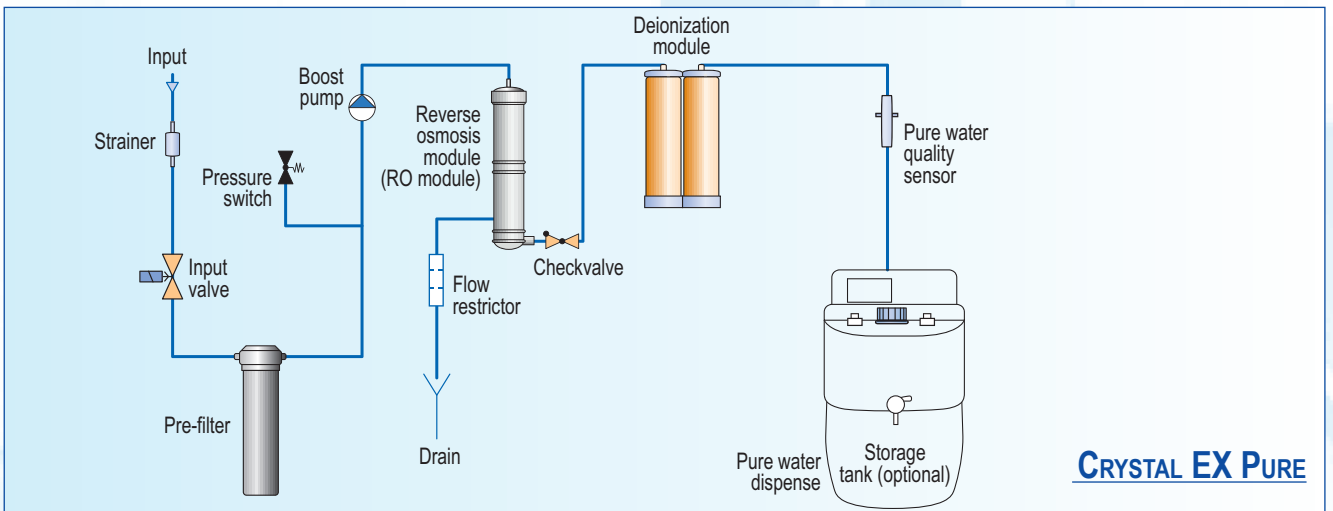
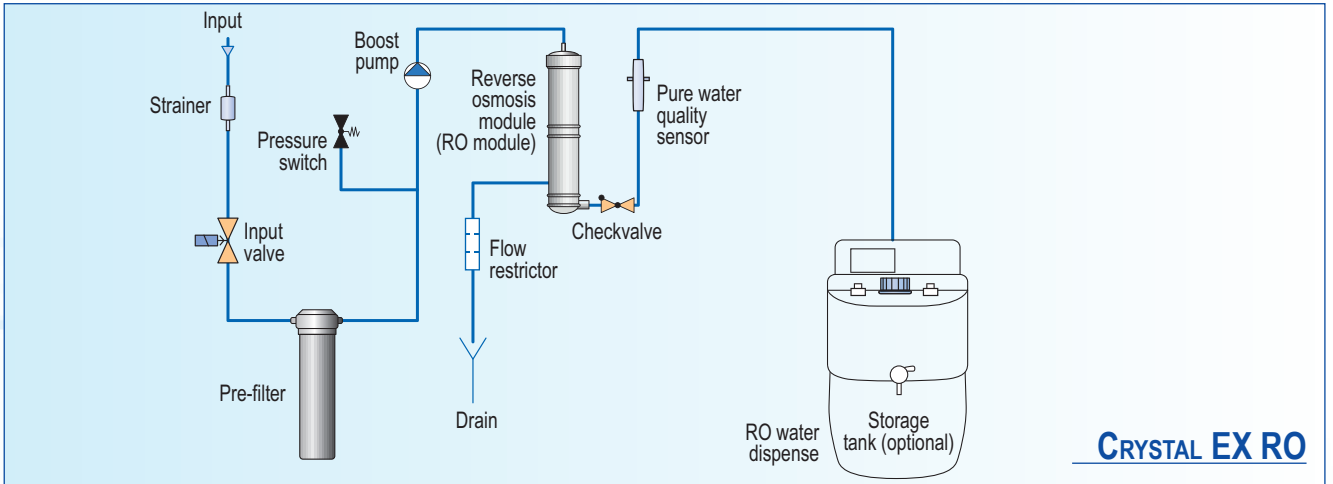



CRYSTAL STERIFEED

Sterifeed is a water purification system specially designed to produce feed water for autoclaves and laboratory washing machines.

Pressurized water storage tank provides consistent water supply to an autoclave. Many autoclaves need pressurized purified water supply. Some autoclaves have priming pumps for purified

water intake, but in case the water supply is not pressurized, an air gap may block the water flow. If the blockage occurs, the operation of autoclave is not possible until the air is removed from the system. Pressurized water storage tank of the "Sterifeed" system eliminates any possibility of air gap formation and ensures smooth operation of an autoclave.

DESCRIPTION

Water type	RO water
Application	purified water for autoclaves
Display	monochrome LCD display
Conductivity sensor	•
TOC Monitor	-
Volumetric dispensing	-
Connection to Flow Point	-
Pressurized storage tank	required, not included
Installation	installable on a wall

ORDERING INFORMATION

Model	Part number
Crystal Sterifeed	CS-1002

SPECIFICATIONS

	Sterifeed
TDS rejection rate	≥97%
Particles >0.22 µm	<1 per mL
Nominal flow, pure water (to storage tank)	10 L/h
Deionization module life	N/A
Dimensions (WxDxH), cm	55x21x50
System weight, kg	11
Operation weight, kg	16
Pressurized storage tank*	60 L
Feed water pressure	0.4 – 4 bar
Feed water conductivity	<1500 µS/cm

* Required but not included. Other capacities available.

CONSUMABLES

Part number	Description	Replacement criteria	Comments
10016	Replacement pre-filter set, Sterifeed	If the filters are clogged or every 6 months	

FLOW DIAGRAM

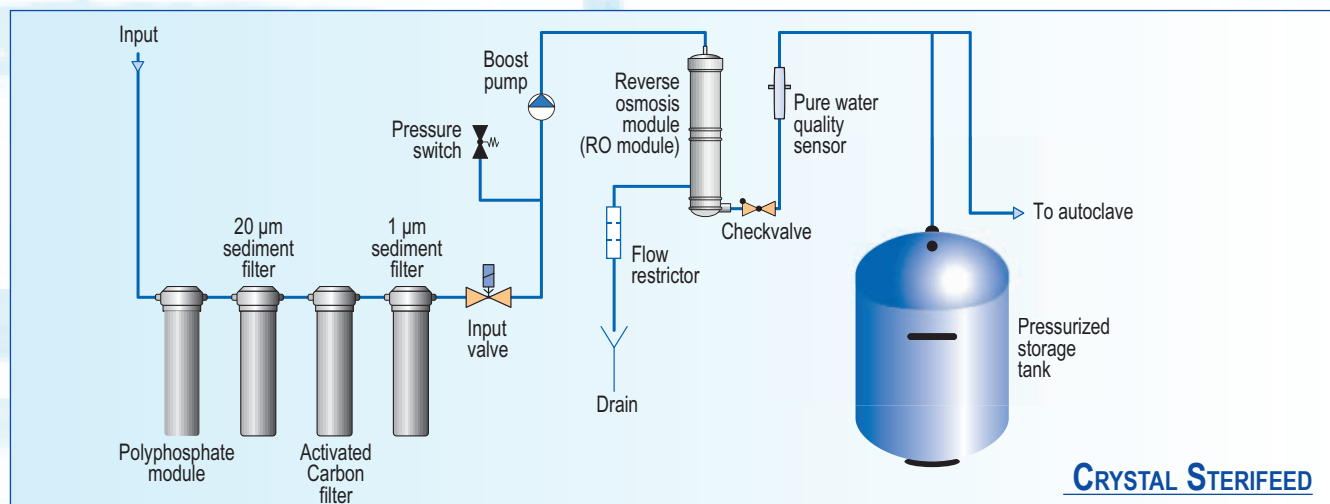

CRYSTAL STERIFEED

ONSITE+

Onsite+ is a polishing water purification system, for which the feed water must be pre-treated by reverse osmosis or distillation.

Onsite+ series systems are recommended for laboratories with average daily consumption of water within 5–10 litres. System contains an embedded tank that has to be filled with pre-treated water before operation. Pre-treated water can be obtained by distillation or reverse osmosis. For user convenience the Onsite+ system comes with additional 5 L carboy. The carboy has a stopcock and handle for easy transportation of water from water still (source) to the Onsite+ unit.



ORDERING INFORMATION

Model	Part number
Onsite+ Trace	CB-1901
Onsite+ HPLC	CB-1903
Onsite+ Bio	CB-1905

DESCRIPTION ONSITE+ SERIES

	Trace	HPLC	Bio
Water type	ultrapure water (Grade 1)	ultrapure water (Grade 1)	ultrapure water (Grade 1)
Application	<ul style="list-style-type: none"> • atomic absorption spectrometry • plasma optical emission spectrometry • other inorganic trace analysis 	<ul style="list-style-type: none"> • chromatography • mass spectrometry • microbiology • molecular biology 	highly sensitive biology applications
Display	colour graphic LCD display		
Conductivity sensor	•	•	•
TOC Monitor	-	•	•
Volumetric dispensing	•	•	•
Connection to Flow point	•	•	•
Storage tank	integrated tank 5 L		
Installation	installable either on a laboratory bench or on a wall		

CONSUMABLES

Part number	Description	Replacement criteria	Comments
10030	Polishing module "Polishing+"	Grade 1 water conductivity is >0.1 µm/cm constantly or every 12 months	
10018	UV photooxidation bulb	2 years on average	Only for „Bio" and „HPLC"
10012	Point-of-use microfilter	Every 6–12 months	Only for „Trace" and „HPLC"
10120	Point-of-use ultrafilter	Every 3–6 months	Only for „Bio"

SPECIFICATIONS

	Trace	HPLC	Bio
Ultrapure water resistivity at 25 °C	18.2 MΩ x cm	18.2 MΩ x cm	18.2 MΩ x cm
Ultrapure water conductivity at 25 °C	0.055 μS/cm	0.055 μS/cm	0.055 μS/cm
Total Organic Carbon (TOC) level	<10 ppb	<5 ppb*	<5 ppb*
RNase	-	-	<0.01 ng/mL
DNase	-	-	<4 pg/μL
Bacteria	<0.01 CFU/mL	<0.01 CFU/mL	<0.01 CFU/mL
Endotoxins	<0.15 EU/mL	<0.15 EU/mL	<0.001 EU/mL
Particles >0.22 μm	<1/mL	<1/mL	<0.05/mL
Dimensions (WxDxH), cm	30x44x64	30x44x64	30x44x64
System weight, kg	16	17	17
Operation weight, kg	21	22	22
Feed water conductivity	< 100 μS/cm	< 100 μS/cm	< 100 μS/cm

* In appropriate operating conditions <2 ppb, otherwise normally <5 ppb.

FLOW DIAGRAMS

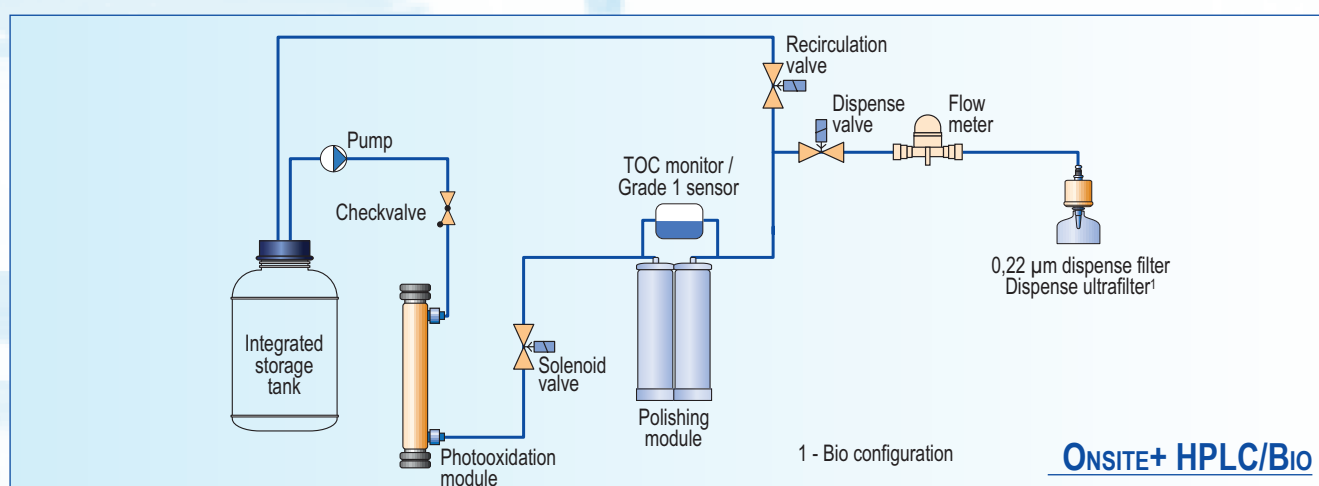
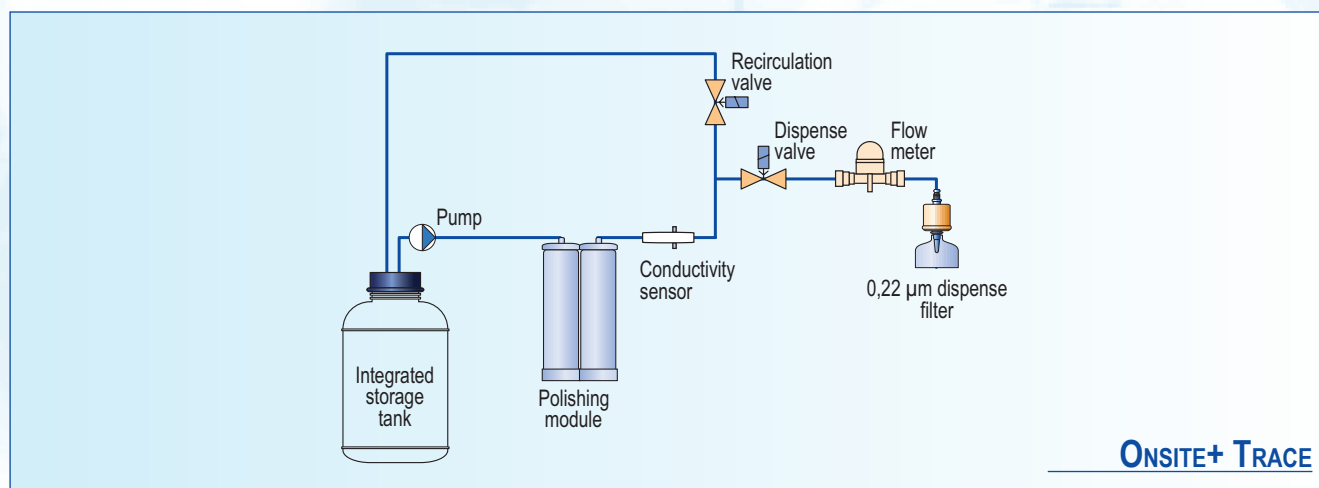

CONNECT

Connect is a polishing water purification system, for which the feed water must be pre-treated by reverse osmosis or distillation.

The unit can be connected to a centralized, pressurized pre-treatment water system or to an external atmospheric tank where pre-treated water is stored.



ORDERING INFORMATION

Model	Part number
Connect Trace	CB-1701
Connect HPLC	CB-1703
Connect Bio	CB-1705

DESCRIPTION CONNECT SERIES

	Trace	HPLC	Bio
Water type	ultrapure water (Grade 1)	ultrapure water (Grade 1)	ultrapure water (Grade 1)
Application	<ul style="list-style-type: none"> • atomic absorption spectrometry • plasma optical emission spectrometry • other inorganic trace analysis 	<ul style="list-style-type: none"> • chromatography • mass spectrometry • microbiology • molecular biology 	highly sensitive biology applications
Display	colour graphic LCD display		
Conductivity sensor	•	•	•
TOC Monitor	-	•	•
Volumetric dispensing	•	•	•
Connection to Flow point	•	•	•
Storage tank	Not included		
Installation	installable either on a laboratory bench or on a wall		

CONSUMABLES

Part number	Description	Replacement criteria	CommLents
10030	Polishing module "Polishing+"	Grade 1 water conductivity is >0.1 µm/cm constantly or every 12 months	
10018	UV photooxidation bulb	2 years on average	Only for „Bio” and „HPLC”
10012	Point-of-use microfilter	Every 6–12 months	Only for „Trace” and „HPLC”
10120	Point-of-use ultrafilter	Every 3–6 months	Only for „Bio”

SPECIFICATIONS

	Trace	HPLC	Bio
Ultrapure water resistivity at 25 °C	18.2 MΩ x cm	18.2 MΩ x cm	18.2 MΩ x cm
Ultrapure water conductivity at 25 °C	0.055 μS/cm	0.055 μS/cm	0.055 μS/cm
Total Organic Carbon (TOC) level	<10 ppb	<5 ppb*	<5 ppb*
RNase	-	-	<0.01 ng/mL
DNase	-	-	<4 pg/μL
Bacteria	<0.01 CFU/mL	<0.01 CFU/mL	<0.01 CFU/mL
Endotoxins	<0.15 EU/mL	<0.15 EU/mL	<0.001 EU/mL
Particles >0.22 μm	<1/mL	<1/mL	<0.05/mL
Dimensions (WxDxH), cm	30x44x64	30x44x64	30x44x64
System weight, kg	16	17	17
Operation weight, kg	19	20	20
Feed water conductivity	< 100 μS/cm	< 100 μS/cm	< 100 μS/cm

* In appropriate operating conditions <2 ppb, otherwise normally <5 ppb.

FLOW DIAGRAM

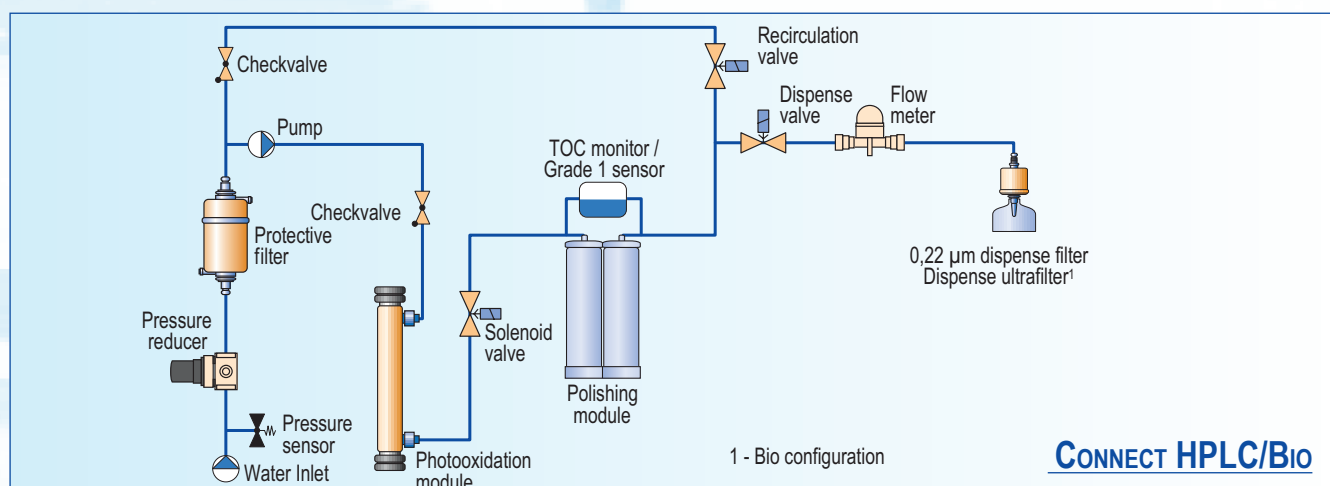
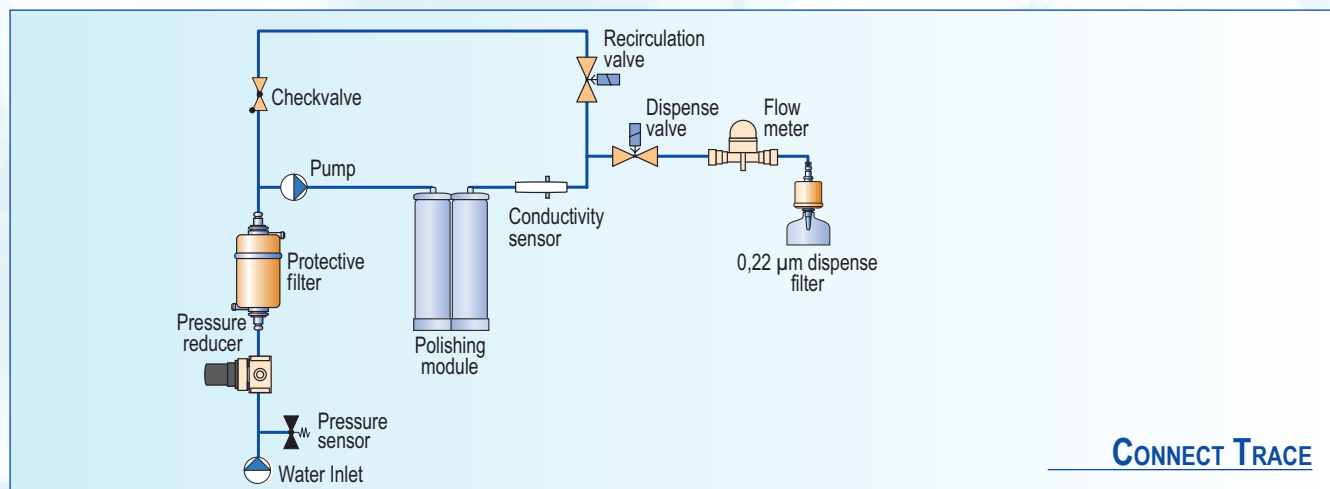

CONNECT LT

The new version of market approved laboratory water polishing system – Connect received totally new electronics and software. As a result there are number of the new features – full colour touch screen, USB and Ethernet connections and available history of dispense reports.

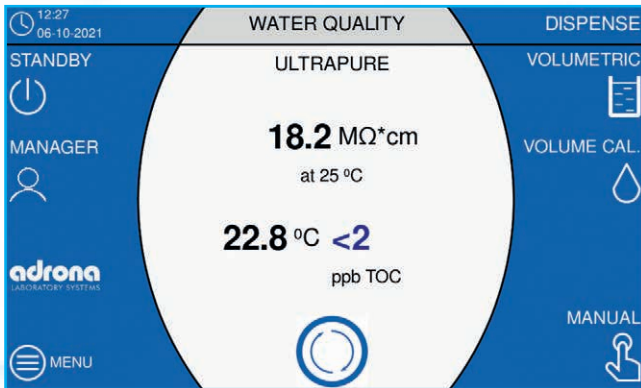

ORDERING INFORMATION

Model	Part number
Connect LT	CB-1801
Connect LT Bio	CB-1803

LARGE TOUCHSCREEN

- Simplified and detailed information in multiple languages
- Alerts and alarms are visible on the main screen with complete information on actions required
- Monitoring the operation of the system

CONVENIENT

- Easy menu navigation in multiple languages
- Easy access to change consumables

COMPACT

- Total dimensions: 290 mm wide, 650 mm high, 440 mm deep
- Integral to your bench space

EASY TO USE

- Water delivered up to 2 liters a minute keeps interruptions to a minimum
- Volumetric dispensing allows fast reissue of volumes
- Volumetric control is available from 0.01 to 100 L

COST EFFECTIVE

- All consumables included
- Large volume DI cartridge
- Space-saving design for a more efficient laboratory setup and daily operation

SPECIFICATIONS

	LT	LT Bio
Grade 1 water resistivity at 25 °C	18.2 MΩ x cm	18.2 MΩ x cm
Grade 1 water conductivity at 25 °C	0.055 µS/ cm	0.055 µS/ cm
TOC	<5 ppb*	<5 ppb*
RNase	-	<0.01 ng/mL
DNase	-	<4 pg/µL
Bacteria	<0.01 CFU/mL	<0.01 CFU/mL
Endotoxins	<0.15 EU/mL	< 0.001 EU/mL
Particles >0.22 µm	<1/ mL	<0.05/ mL
Dispense rate, ultrapure water	1.5 - 2 L/min	1.5 - 2 L/min
Dimensions (WxDxH), cm	29x44x65	29x44x65
System weight, kg	17	17
Operation weight, kg	20	20
Feed water conductivity	< 100 µS/cm	< 100 µS/cm

*In appropriate operating conditions <2 ppb, otherwise normally <5 ppb.

DESCRIPTION

	LT	LT Bio
Water type	ultrapure water (Grade 1)	ultrapure water (Grade 1)
Application	<ul style="list-style-type: none"> • chromatography • mass spectrometry • microbiology • molecular biology 	highly sensitive biology applications
Display	7" colour touchscreen	
Conductivity sensor	•	•
TOC Monitor	•	•
Volumetric dispensing	•	•
Connection to Flow point	•	•
Installation	installable either on a laboratory bench or on a wall	

CONSUMABLES

Part number	Description	Replacement criteria	Comments
10031	Polishing Q w/ quick connectors	Grade 1 water conductivity is >0.1 µm/cm constantly or every 12 months	Depends on water consumption amount
10018	Photooxidation UV bulb	On average – every 2 years	"LT" and "LT Bio" configuration
10012	Replacement 0.22 µm dispense filter	Every 6–12 months	"LT" configuration
10120	Replacement ultrafilter	Every 3–6 months	"LT Bio" configuration

FLOW DIAGRAM

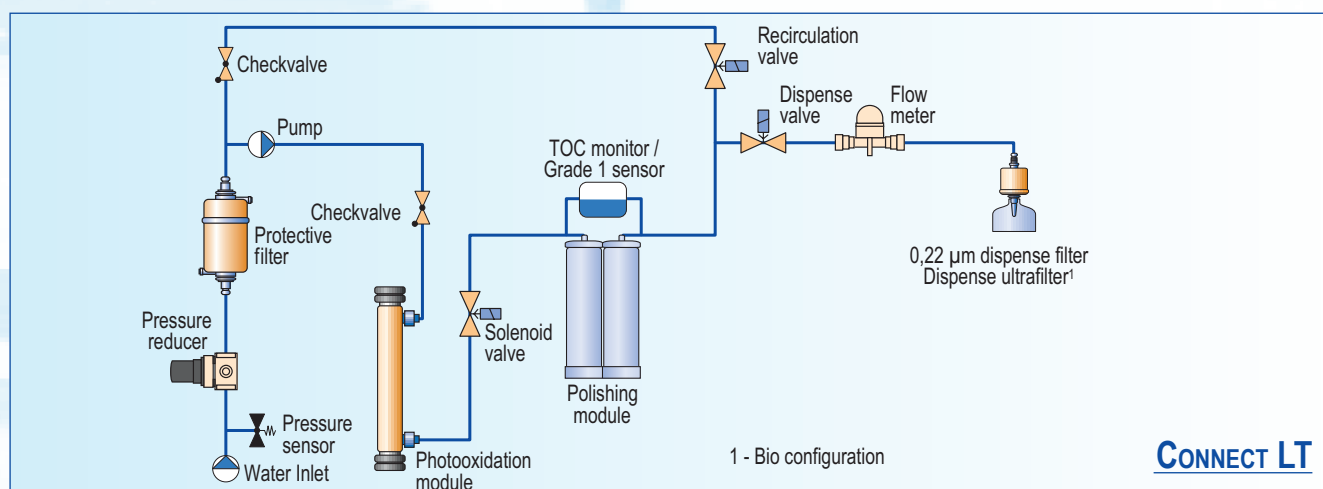

RADIX

When larger quantities of Grade 2 or RO water are required, RADIX systems serve as a multi-purpose solution for a wide range of applications. Systems are available in RO or EDI configurations and, depending on the model, produce up to 250 L of RO water or 90 L of Grade 2 water per hour.

RADIX systems are designed as robust and reliable high-capacity purified water sources that require minimal maintenance while delivering exceptional output. The EDI configuration includes an electrodeionization module which needs no replacement and thus the long-term running costs are kept as low as possible.

Typical fields of application include, but are not limited to:

- Central laboratory water distribution system which can supply purified water to the entire facility with a number of point-of-use access points and additional Grade 1 polishers installed according to the specific requirements.
- Feed water production to biochemical analyzers in hospitals, laboratories, healthcare centers (RADIX EDI – Grade 2 systems). Depending on water consumption, RADIX systems can simultaneously supply more than one analyzer. A typical setup includes the RADIX system, an atmospheric storage tank (equipped with an automatic UV sanitization module and CO₂ trap) and a water distribution module.
- Production facilities of different types of manufacturing industries.
- Supply of large capacity humidifiers, steam generators etc.



ORDERING INFORMATION

Model	Part number
Radix 60 RO	RA-1001
Radix 100 RO	RA-1003
Radix 250 RO	RA-1005
Radix 31 EDI	RA-2102
Radix 61 EDI	RA-2104
Radix 91 EDI	RA-2106

SPECIFICATIONS

	60 RO	100 RO	250 RO	31 EDI	61 EDI	91 EDI
Capacity, L/h	60	100	250	30	60	90
TDS rejection rate	≥98.5%	≥98.5%	≥ 98.5%	-	-	-
Output water conductivity at 25 °C, µS/cm	-	-	-	≤0.5	≤0.5	≤0.5
Dimensions (WxDxH), cm	33x65x72	33x65x72	65x94x72	33x65x72	33x65x72	33x65x72
System weight, kg	42	56	88	50	56	60
Operation weight, kg	52	63	97	55	63	66
Display	colour graphic LCD display					
Storage tank	required, not included					

CONSUMABLES

Part number	Description	Replacement criteria
10420	Pre-filter RADIPACK	If the filters are clogged or every 6 months
10011	Replacement sterilization UV bulb	As required (on average every 2 years)

FLOW DIAGRAM

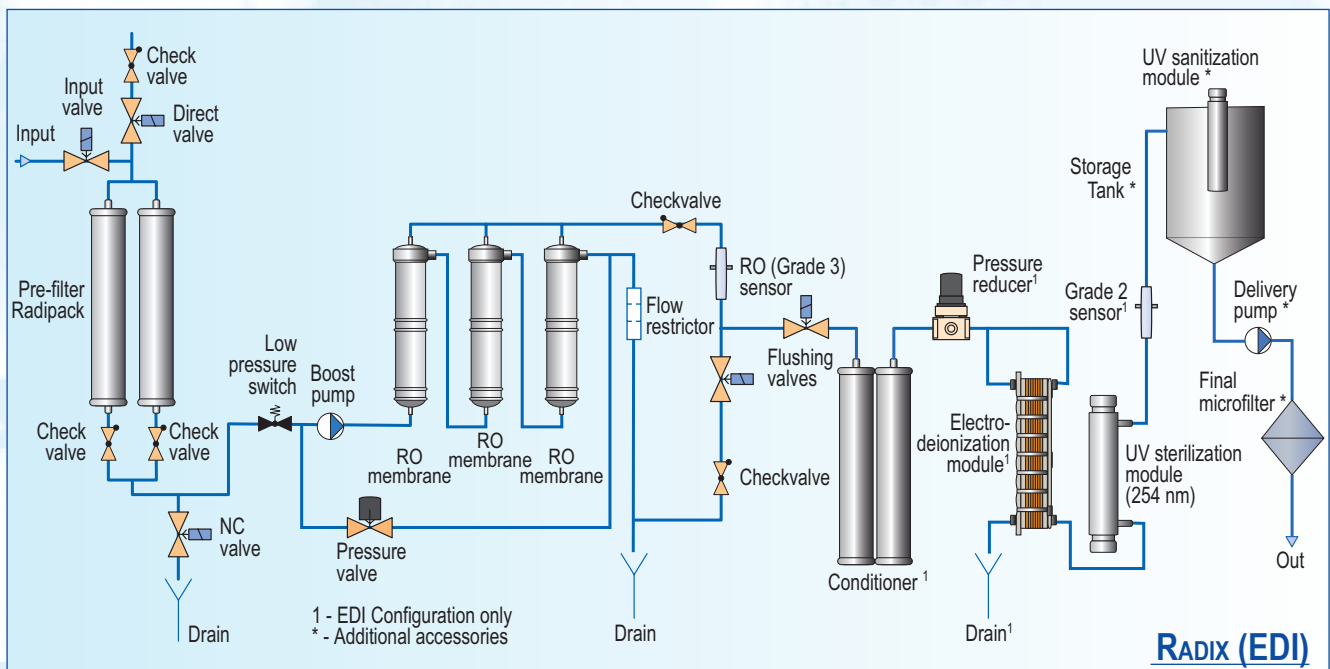

ACCESSORIES

For increased convenience of use of the Adrona water purification systems, choose from the variety of accessories to meet your specific needs.

STORAGE TANKS

Adrona water purification systems can be equipped with water storage tanks of various capacity. Depending on the consumption of purified water, user can choose the tank starting from tank with capacity of 30 litres up to 300 litres. All the storage tanks are equipped with level switch.

WATER STORAGE TANK “PRO”



Specially designed for significant reduction of microbiological contamination possibilities

Features:

- 30 L geometric volume
- 25 L usable volume
- Opaque housing walls for protection against light
- Conical bottom for complete draining
- Ergonomical design
- Equipped with stopcock
- Recirculation system for maintaining the water quality
- Automatic UV sanitization (UV lamp) module (option)
- Multi-position level switch, that enables precise control of remaining water
- Fast pure water dispense pump (option)
- Dimensions (WxDxH): 39x44x60 cm
- Weight: 6.5 kg

WATER DISPENSING UNIT “FLOW POINT”



Water dispensing unit provides more convenient use of Adrona systems.

- Adjustable in all dimensions
- Manual and/or volumetric dispensing with teaching mode
- Colour graphic LCD display
- Full remote control for water purification system

ORDERING INFORMATION

Model	Part number
Water dispensing unit “Flow Point 4”	10426
Water dispensing unit “Flow Point 3”	10326
Universal remote dispenser	13009
Water storage tank “Pro” w/ multipoint level sensor, 30 L	11015
Water storage tank “Comfort” w/ multipoint level sensor, 60 L	10007
Water storage tank “Comfort” w/ dispense pump, w/ base, 100 L	11027
Water storage tank “Comfort” w/ dispense pump, w/ base, 200 L	10026
Water storage tank “Comfort” w/ dispense pump, w/ base, 300 L	10025
Automatic sanitization module for tank “Pro”	10315
UV sterilization module	10103

WATER STORAGE TANK
“COMFORT” 60 L



LABORATORY WATER SYSTEM SERVICE ACCESSORIES

Part number	Model	Specification
2CA300	Conductometer WTW cond 3310	0.0001-30 $\mu\text{S}/\text{cm}$
301962	Utrapure water conductivity cell	
91220	Hardness test strips	
HI98308	Conductivity tester PWT	0.00-99.9 $\mu\text{S}/\text{cm}$
HI98304	Conductivity tester DIST4	0.00-20 mS/cm



ISO 9001

BUREAU VERITAS
Certification



adrona

Kalnciema str. 209, Rīga
LATVIA, LV – 1046
Tel.: +371 67551894, +371 67551993
Fax: +371 67551976
e-mail: info@adrona.lv
www.adrona.eu